

**EPSON**  
EXCEED YOUR VISION

# **User's Guide**



# **Multimedia Projector**

**EB-W16SK**





## Notations Used in This Guide

- **Safety indications**

The documentation and the projector use graphical symbols to show how to use the projector safely. Please understand and respect these caution symbols in order to avoid injury to persons or property.

 <b>Warning</b>	This symbol indicates information that, if ignored, could possibly result in personal injury or even death due to incorrect handling.
 <b>Caution</b>	This symbol indicates information that, if ignored, could possibly result in personal injury or physical damage due to incorrect handling.

- **General information indications**

<b>Attention</b>	Indicates procedures which may result in damage or injury if sufficient care is not taken.
	Indicates additional information and points which may be useful to know regarding a topic.
	Indicates a page where detailed information regarding a topic can be found.
	Indicates that an explanation of the underlined word or words in front of this symbol appears in the glossary of terms. See the "Glossary" section of the "Appendix".  "Glossary" <a href="#">p.106</a>
[Name]	Indicates the name of the buttons on the remote control or the control panel. Example: [Esc] button
Menu Name	Indicates Configuration menu items. Example: Select <b>Brightness</b> from <b>Image</b> . <b>Image - Brightness</b>



## Notations Used in This Guide ..... 2

### Introduction

---

#### Projector Features ..... 7

Stacking Two Projectors .....	7
Superimpose Two Images with Ease .....	7
Project Realistic 3D Images .....	7
Useful Functions for Projecting Images .....	7
Increasing projection content in wide (WXGA) screen .....	7
Making the most of the remote control .....	7
Enhanced security functions .....	8

#### Part Names and Functions ..... 9

Device Configuration .....	9
Front/Top .....	9
Side .....	10
Rear .....	11
Base .....	12
Control Panel .....	13
Remote Control .....	15
Replacing the remote control batteries .....	17
Remote control operating range .....	18

### Preparing the Projector

---

#### Installing the Projector ..... 20

Installation Methods .....	20
----------------------------	----

#### Connecting Equipment ..... 21

Connecting the Commander and the Receiver .....	21
Connecting a Computer .....	22
Connecting with computer cables .....	22
Connecting with HDMI cables .....	24
Connecting Image Sources .....	25

Connecting with HDMI cables .....	25
Connecting with video cables .....	26
Connecting with S-video cables .....	27
Connecting with component video cables .....	28
Connecting External Equipment .....	29

### Basic Usage

---

#### Projecting Images ..... 32

From Installation to Projection .....	32
Automatically Detect Input Signals and Change the Projected Image (Source Search) .....	34
Switching to the Target Image by Remote Control .....	35

#### Adjusting Projected Images ..... 36

Superimposing Two Images .....	36
Adjusting the Image Size .....	36
Adjusting the Image Position .....	36
Adjusting the Horizontal Tilt .....	36
Correcting the Focus .....	37
Adjusting the Volume .....	37
Selecting the Projection Quality (Selecting Color Mode) .....	37
Setting Auto Iris .....	38
Changing the Aspect Ratio of the Projected Image .....	39
Changing methods .....	39
Changing the aspect mode .....	39

### Useful Functions

---

#### Projection Functions ..... 42

Projecting 3D Images .....	42
Preparing to view 3D images .....	42
Supported 3D signals .....	42
Viewing methods for 3D images .....	42
Viewing area for 3D images .....	43
Warnings regarding viewing 3D images .....	43

Hiding the Image and Sound Temporarily (A/V Mute) . . . . .	45
Freezing the Image (Freeze) . . . . .	46
Enlarging Part of the Image (E-Zoom) . . . . .	47

## Security Functions . . . . . 48

Managing Users (Password Protect) . . . . .	48
Kinds of Password Protect . . . . .	48
Setting Password Protect . . . . .	48
Entering the Password . . . . .	49
Restricting Operation (Control Panel Lock) . . . . .	50
Anti-Theft Lock . . . . .	52
Installing the wire lock . . . . .	52

## Monitoring and Controlling . . . . . 53

ESC/VP21 Commands . . . . .	53
Before getting started . . . . .	53
Command list . . . . .	53
Communications protocol . . . . .	54

## Configuration Menu

---

### Using the Configuration Menu . . . . . 56

### List of Functions . . . . . 57

Configuration Menu Table . . . . .	57
Image Menu . . . . .	58
Signal Menu . . . . .	58
Settings Menu . . . . .	60
Extended Menu . . . . .	61
Info Menu (Display Only) . . . . .	62
Reset Menu . . . . .	63

## Troubleshooting

---

### Using the Help . . . . . 65

### Problem Solving . . . . . 67

Reading the Indicators . . . . .	67
When the Indicators Provide No Help . . . . .	71
Problems Relating to Images . . . . .	72
No images appear . . . . .	72
Moving images are not displayed . . . . .	73
Projection stops automatically . . . . .	73
The message Not supported is displayed . . . . .	73
The message No Signal is displayed . . . . .	73
Cannot view 3D images . . . . .	74
Images are fuzzy, out of focus, or distorted . . . . .	75
Interference or distortion appear in images . . . . .	75
The image is truncated (large) or small, the aspect is not suitable, or the image has been reversed . . . . .	76
Image colors are not right . . . . .	76
Images appear dark . . . . .	77
Problems when Projection Starts . . . . .	77
The projector does not turn on . . . . .	77
One of the projectors is not turned on, or the projectors have not been linked together . . . . .	78
Other Problems . . . . .	78
No sound can be heard or the sound is faint . . . . .	78
The remote control does not work . . . . .	79
I want to change the language for messages and menus . . . . .	80

## Maintenance

---

### Cleaning . . . . . 82

Cleaning the Projector's Surface . . . . .	82
Cleaning the Lens . . . . .	82
Cleaning the Polarizer . . . . .	82
Cleaning the 3D Glasses . . . . .	82
Cleaning the Air Filter . . . . .	83

### Replacing Consumables . . . . . 84

Replacing the Lamp . . . . .	84
Lamp replacement period . . . . .	84
How to replace the lamp . . . . .	84



Resetting the lamp hours . . . . . 88  
 Replacing the Air Filter . . . . . 88  
     Air filter replacement period . . . . . 88  
     How to replace the air filter . . . . . 88

**Index . . . . . 110**

## Appendix

---

### **Clearing Stack Mode and then Using a Projector . . . . . 91**

Turning On One Projector in a Stacked Configuration . . . . . 91  
     Turning on only the commander . . . . . 91  
     Turning on only the receiver . . . . . 91  
 Clearing the Stacked Configuration and Using One Projector . . . . . 91

### **Optional Accessories and Consumables . . . . . 94**

Optional Accessories . . . . . 94  
 Consumables . . . . . 95

### **Screen Size and Projection Distance . . . . . 96**

Projection Distance . . . . . 96

### **Supported Monitor Displays . . . . . 98**

Supported Resolutions . . . . . 98  
     Computer signals (analog RGB) . . . . . 98  
     Component Video . . . . . 98  
     Composite video . . . . . 98  
     Input signal from the HDMI port . . . . . 98  
     3D Input Signal . . . . . 99

### **Specifications . . . . . 100**

Projector General Specifications . . . . . 100

### **Appearance . . . . . 105**

### **Glossary . . . . . 106**

### **General Notes . . . . . 108**

About Notations . . . . . 108  
 Trademarks and Copyrights . . . . . 108



# Introduction

This chapter explains the projector's features and the part names.

## Stacking Two Projectors

Two projectors are stacked one on top of the other to project one image. By using this stacked projection, you can realize a brighter, clearer image.

Because the projectors are linked together, you can operate both projectors as if you were only operating one.

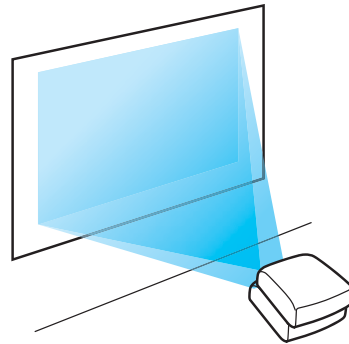

## Superimpose Two Images with Ease

This device comes equipped with a function that allows you to easily superimpose two images. See the following manual when superimposing images for the first time after installation.

☛ [Startup Guide](#)

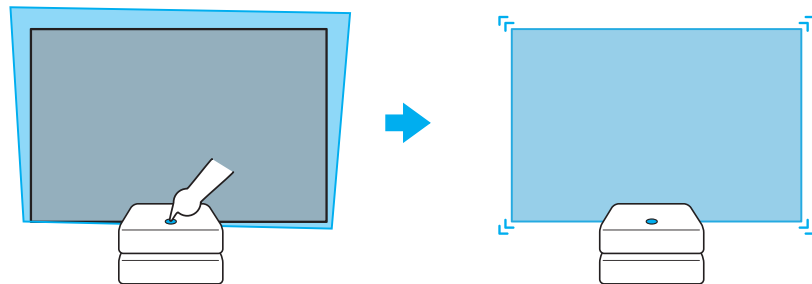

## Project Realistic 3D Images

Project stunning 3D content from media such as 3D Blu-ray discs or 3D games. You need the supplied or optional 3D Glasses (ELPGS02A/ELPGS02B) and a commercially available silver screen to view 3D images.

☛ ["Projecting 3D Images" p.42](#)

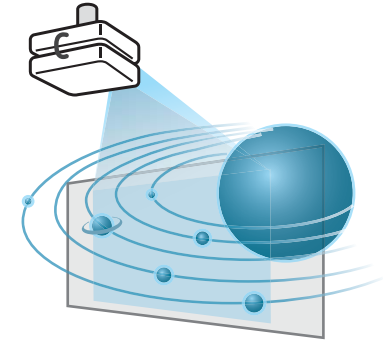

## Useful Functions for Projecting Images

### Increasing projection content in wide (WXGA) screen

With a computer that has a 16:10 WXGA wide LCD display, the image can be projected in the same aspect. You can use whiteboards and other landscape format screens.

☛ ["Changing the Aspect Ratio of the Projected Image" p.39](#)

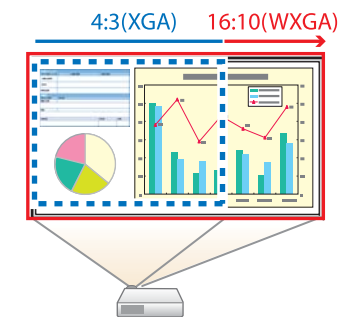

### Making the most of the remote control

You can use the remote control to perform operations such as enlarging part of the image.

☛ ["Enlarging Part of the Image \(E-Zoom\)" p.47](#)

☛ ["Hiding the Image and Sound Temporarily \(A/V Mute\)" p.45](#)

## Enhanced security functions

- **Password Protect to restrict and manage users**

By setting a Password you can restrict who can use the projector.

☛ "Managing Users (Password Protect)" [p.48](#)

- **Control Panel Lock to restrict button operation on the control panel**

You can use this to prevent people changing projector settings without permission at events, in schools, and so on.

☛ "Restricting Operation (Control Panel Lock)" [p.50](#)

- **Equipped with various anti-theft devices**

The projector is equipped with the following types of anti-theft security devices.

- Security slot
- Security cable installation point

☛ "Anti-Theft Lock" [p.52](#)



## Device Configuration

This device is comprised of two projectors.

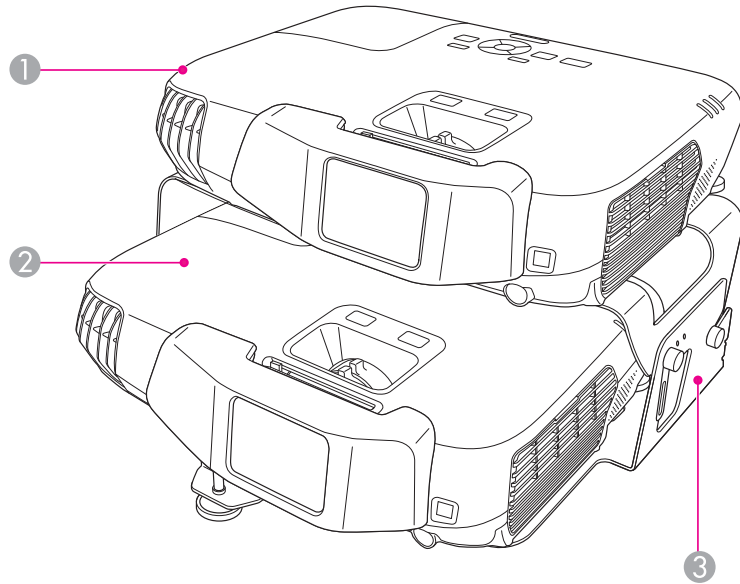

	Name	Function
1	<b>Commander</b>	Controls the receiver and combines two projectors. You can perform projector operations from the commander's control panel or the remote control. A sticker labeled "1" is stuck to the base of the commander.
2	<b>Receiver</b>	When you operate the commander, the receiver performs the same operations. A sticker labeled "2" is stuck to the base of the receiver.
3	<b>Stacker mount</b>	This mount installs the commander and the receiver in a stacked configuration.

## Front/Top

The following example uses the commander. The receiver performs the same operations.

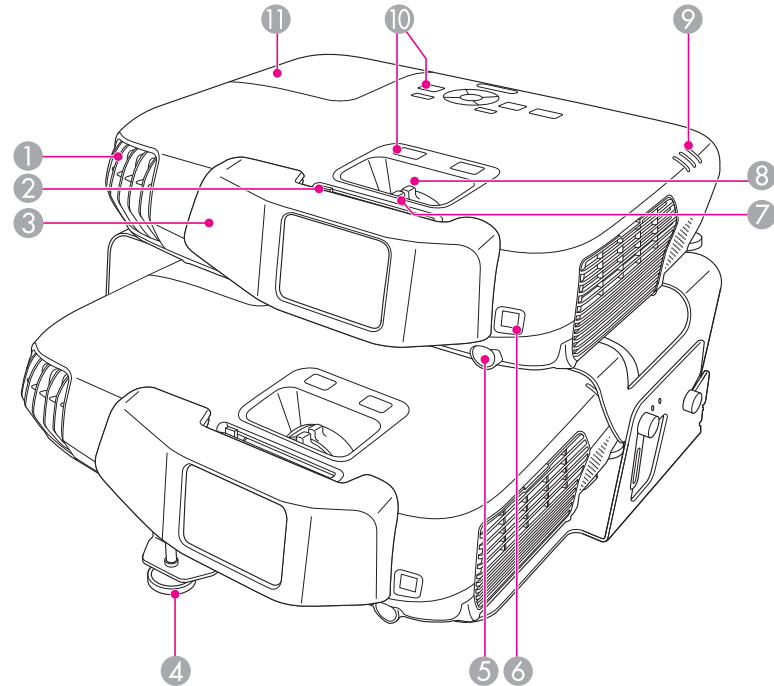

	Name	Function
1	<b>Air exhaust vent</b>	Exhaust vent for air used to cool the projector internally. <div style="border: 1px solid black; padding: 5px; margin-top: 10px;"> <p><b>⚠ Caution</b></p> <p>While projecting, do not put your face or hands near the air exhaust vent, and do not place objects that may become warped or damaged by heat near the vent. Hot air from the air exhaust vent could cause burns, warping, or accidents to occur.</p> </div>

Name	Function
2 <b>A/V mute slide knob</b>	Slide the knob to open and close the A/V mute slide. By closing the A/V mute slide during projection you can hide the image and the sound. ☛ "Hiding the Image and Sound Temporarily (A/V Mute)" p.45
3 <b>Polarizer</b>	Used for viewing 3D images. See the following manual for more information on attaching the polarizer. ☛ <a href="#">Startup Guide</a>
4 <b>Front adjustable foot</b>	When setup on a surface such as a desk, extend the foot to adjust the position of the image. ☛ "Adjusting the Image Position" p.36
5 <b>Remote receiver</b>	Receives signals from the remote control.
6 <b>Sensor</b>	This sensor allows two images to be placed on top of each other.
7 <b>Focus ring</b>	Adjusts the image focus. ☛ "Correcting the Focus" p.37
8 <b>Zoom ring</b>	Adjusts the image size. ☛ "Adjusting the Image Size" p.36
9 <b>Indicators</b>	Indicates the projector's status. ☛ "Reading the Indicators" p.67
10 <b>Control panel</b>	Operates the projector. ☛ "Control Panel" p.13
11 <b>Lamp cover</b>	Open when replacing the projector's lamp. ☛ "Replacing the Lamp" p.84

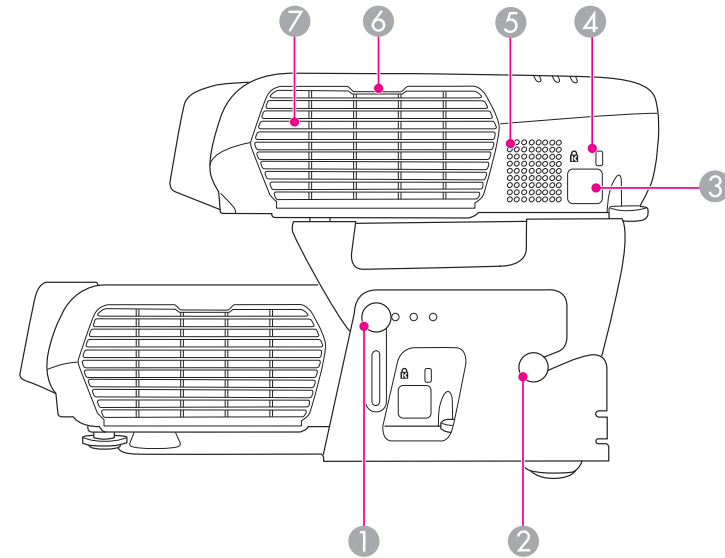

Name	Function
1 <b>Stacker angle adjustment section</b>	Adjusts the commander's projection angle according to the projection distance. ☛ <a href="#">Startup Guide</a>
2 <b>Stacker mount connector</b>	Connects the mount and the screws hold it in place. ☛ <a href="#">Startup Guide</a>
3 <b>Security cable installation point</b>	Pass a commercially available wire lock through here and lock it in place. ☛ "Installing the wire lock" p.52
4 <b>Security slot</b>	The security slot is compatible with the Microsaver Security System manufactured by Kensington. ☛ "Anti-Theft Lock" p.52
5 <b>Speaker</b>	Outputs audio.
6 <b>Air filter cover section</b>	Place your finger to open the air filter cover. ☛ "Replacing the Air Filter" p.88
7 <b>Air intake vent (air filter)</b>	Takes in air to cool the projector internally. ☛ "Cleaning the Air Filter" p.83

## Side

The following example uses the commander. The receiver performs the same operations.

## Rear

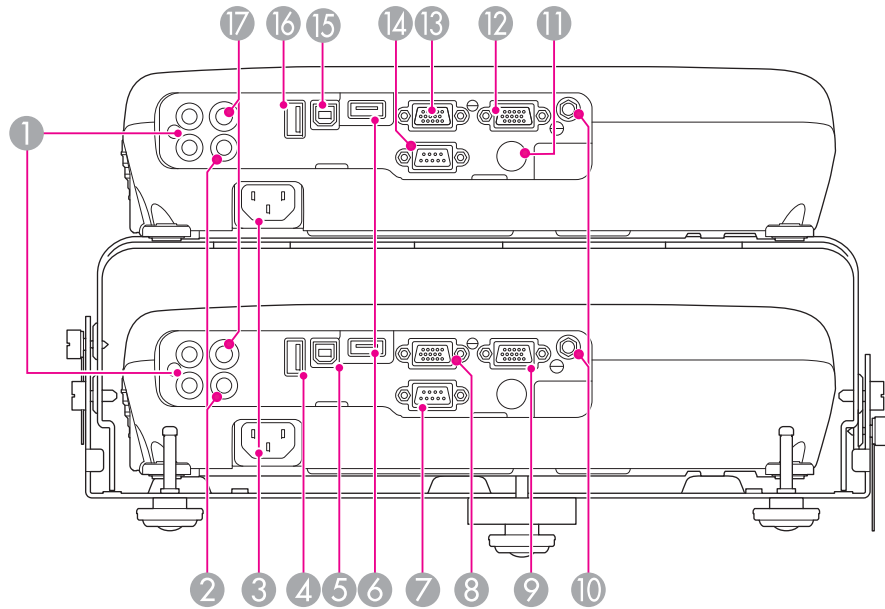



Name	Function
① <b>Audio-L/R port</b>	Inputs audio from equipment connected to the Computer port, the S-Video port, or the Video port.
② <b>Video port</b>	Inputs composite video signals from video sources. By using a splitter, you can input signals to the Video port for the commander and the receiver.
③ <b>Power inlet</b>	Connects the power cord to the projector. ☛ "From Installation to Projection" p.32
④ <b>USB(TypeA) port</b>	This cannot be used on the receiver.
⑤ <b>USB(TypeB) port</b>	Connects a USB cable to the commander's USB(TypeA) port (⑩). This is used to control receiver operations from the commander.

Name	Function
⑥ <b>HDMI port</b>	Inputs video signals from HDMI compatible video equipment and computers. By using a splitter, you can input signals to the HDMI port for the commander and the receiver. This projector is compatible with <u>HDCP</u> ▶▶.
⑦ <b>RS-232C port</b>	This cannot be used on the receiver.
⑧ <b>Computer1 port</b>	Inputs image signals from a computer and component video signals from other video sources. <ul style="list-style-type: none"> <li>• When using a splitter Connect a computer cable to the splitter.</li> <li>• When not using a splitter Connect a computer cable to the commander's Monitor Out/Computer2 port (⑫).</li> </ul>
⑨ <b>Monitor Out/Computer2 port</b>	Outputs analog RGB signals input from the Computer1 port to an external monitor. You cannot output signals input from other ports or component video signals.
⑩ <b>Audio Out port</b>	Outputs audio from the currently projected image to an external speaker.
⑪ <b>Remote receiver</b>	Receives signals from the remote control.
⑫ <b>Monitor Out/Computer2 port</b>	Connect a computer cable to the receiver's Computer1 port (⑧). (Only if you are not using a splitter when projecting a computer image.)
⑬ <b>Computer1 port</b>	Inputs image signals from a computer and component video signals from other video sources.
⑭ <b>RS-232C port</b>	When controlling the projector from a computer, connect it to the computer with an RS-232C cable. This port is for control use and should not normally be used. ☛ "ESC/VP21 Commands" p.53
⑮ <b>USB(TypeB) port</b>	This cannot be used on the commander.

Name	Function
16 <b>USB(TypeA) port</b>	Connects a USB cable to the receiver's USB(TypeB) port (5). This is used to control receiver operations from the commander.
17 <b>S-Video port</b>	Inputs S-Video signals from video sources. By using a splitter, you can input signals to the S-Video port for the commander and the receiver.

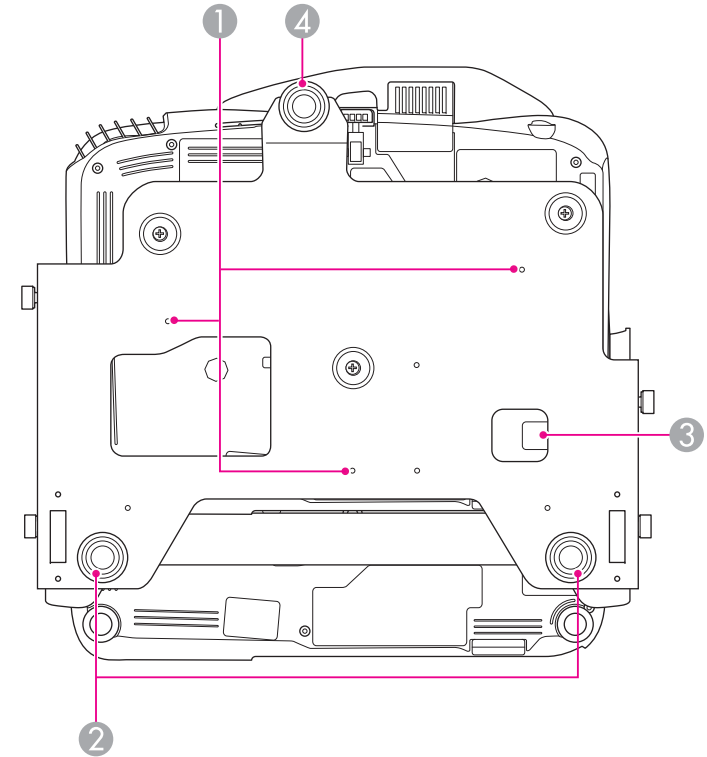
## Base



Name	Function
1 <b>Ceiling mount fixing points (three points)</b>	Attach the optional Ceiling Mount here when suspending the projectors from a ceiling.  "Installing the Projector" p.20  "Optional Accessories" p.94

Name	Function
② <b>Rear feet</b>	When setup on a surface such as a desk, turn to extend and retract to adjust the horizontal tilt. 🖱️ "Adjusting the Horizontal Tilt" <a href="#">p.36</a> See the following manual for more information on attaching the rear feet. 🖱️ <a href="#">Startup Guide</a>
③ <b>Security cable installation point</b>	Pass a commercially available wire lock through here and lock it in place. 🖱️ "Installing the wire lock" <a href="#">p.52</a>
④ <b>Front adjustable foot</b>	When setup on a surface such as a desk, extend the foot to adjust the position of the image. 🖱️ "Adjusting the Image Position" <a href="#">p.36</a> See the following manual for more information on attaching the front foot. 🖱️ <a href="#">Startup Guide</a>

## Control Panel

You can perform projector operations from the commander's control panel. The receiver's control panel cannot be used while projecting in a stacked configuration.

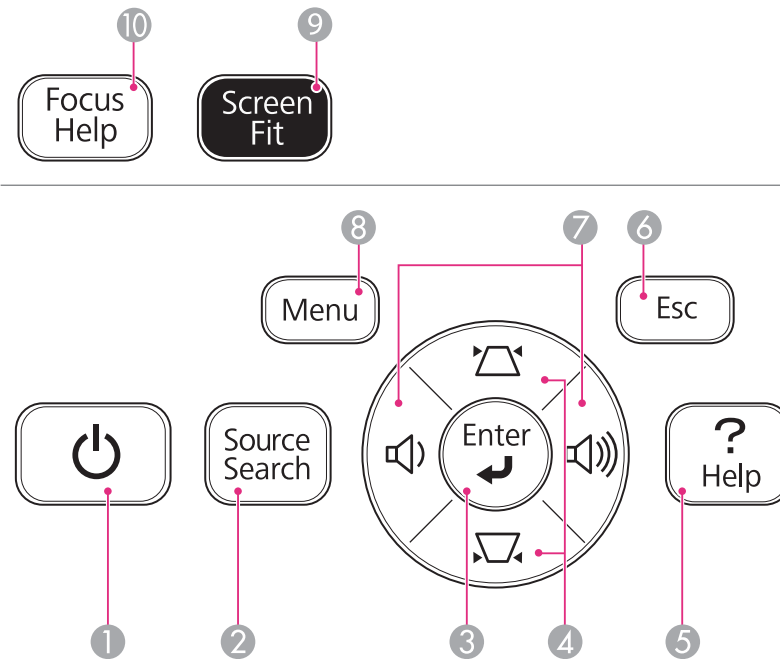

Name	Function
① <b>[Power] button</b>	Turns the projector power on or off. 🖱️ "From Installation to Projection" <a href="#">p.32</a>
② <b>[Source Search] button</b>	Changes to the next input source that is sending an image. 🖱️ "Automatically Detect Input Signals and Change the Projected Image (Source Search)" <a href="#">p.34</a>

Name		Function
③	<b>[Enter] button</b> [↵]	<ul style="list-style-type: none"> <li>When the Configuration menu or the Help screen is displayed, it accepts and enters the current selection and moves to the next level.</li> <li>If pressed while projecting analog RGB signals from the Computer port, you can automatically optimize Tracking, Sync., and Position.</li> </ul>
④	<b>[△][▽] buttons</b>	<ul style="list-style-type: none"> <li>If pressed when the Configuration menu or the Help screen is displayed, these buttons select menu items and setting values.                             <ul style="list-style-type: none"> <li>"Using the Configuration Menu" <a href="#">p.56</a></li> <li>"Using the Help" <a href="#">p.65</a></li> </ul> </li> </ul>
⑤	<b>[Help] button</b>	<p>Displays and closes the Help screen which shows you how to deal with problems if they occur.</p> <ul style="list-style-type: none"> <li>"Using the Help" <a href="#">p.65</a></li> </ul>
⑥	<b>[Esc] button</b>	<ul style="list-style-type: none"> <li>Stops the current function.</li> <li>If pressed when the Configuration menu is displayed, it moves to the previous menu level.                             <ul style="list-style-type: none"> <li>"Using the Configuration Menu" <a href="#">p.56</a></li> </ul> </li> </ul>
⑦	<b>[&lt;⏪][&lt;⏩] buttons</b>	<ul style="list-style-type: none"> <li>Adjusts the speaker volume.                             <ul style="list-style-type: none"> <li>[&lt;⏩] Increases the volume.</li> <li>[&lt;⏪] Decreases the volume.</li> <li>"Adjusting the Volume" <a href="#">p.37</a></li> </ul> </li> <li>If pressed when the Configuration menu or the Help screen is displayed, these buttons select menu items and setting values.                             <ul style="list-style-type: none"> <li>"Using the Configuration Menu" <a href="#">p.56</a></li> <li>"Using the Help" <a href="#">p.65</a></li> </ul> </li> </ul>
⑧	<b>[Menu] button</b>	<p>Displays and closes the Configuration menu.</p> <ul style="list-style-type: none"> <li>"Using the Configuration Menu" <a href="#">p.56</a></li> </ul>
⑨	<b>[Screen Fit] button</b>	<p>Adjusts the image so that two images are superimposed correctly. See the following manual when superimposing images for the first time after installation.</p> <ul style="list-style-type: none"> <li><a href="#">Startup Guide</a></li> </ul>

Name		Function
⑩	<b>[Focus Help] button</b>	This cannot be used while projecting in a stacked configuration.

## Remote Control

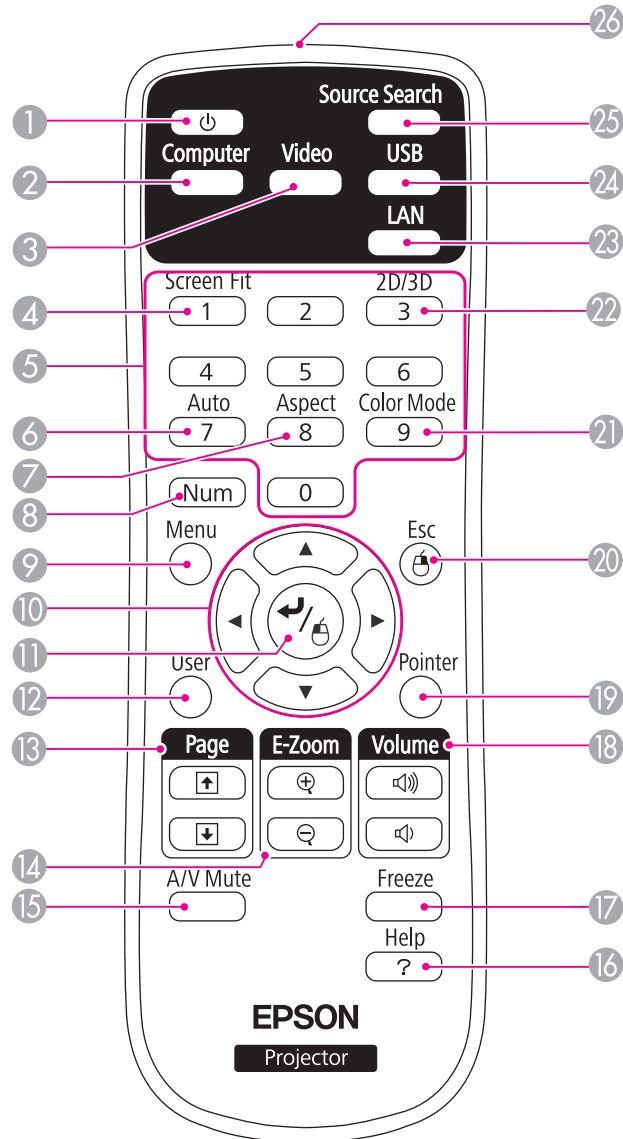

	Name	Function
①	[Power] button	Turns the projector power on or off. ☛ "From Installation to Projection" p.32
②	[Computer] button	Changes to images from the Computer port.
③	[Video] button	Each time the button is pressed, the image cycles through the S-Video, Video, and HDMI ports.
④	[Screen Fit] button	Adjusts the image so that two images are superimposed correctly. See the following manual when superimposing images for the first time after installation. ☛ <i>Startup Guide</i>
⑤	Numeric buttons	Enter the Password. ☛ "Setting Password Protect" p.48
⑥	[Auto] button	If pressed while projecting analog RGB signals from the Computer port, you can automatically optimize Tracking, Sync., and Position.
⑦	[Aspect] button	Each time the button is pressed, the aspect mode changes. ☛ "Changing the Aspect Ratio of the Projected Image" p.39
⑧	[Num] button	Hold down this button and press the numeric buttons to enter passwords and numbers. ☛ "Setting Password Protect" p.48
⑨	[Menu] button	Displays and closes the Configuration menu. ☛ "Using the Configuration Menu" p.56
⑩	[Left/Right/Up/Down] buttons	<ul style="list-style-type: none"> <li>When the Configuration menu or the Help screen is displayed, pressing these buttons selects menu items and setting values. ☛ "Using the Configuration Menu" p.56</li> </ul>
⑪	[Enter] button	<ul style="list-style-type: none"> <li>When the Configuration menu or the Help screen is displayed, it accepts and enters the current selection and moves to the next level. ☛ "Using the Configuration Menu" p.56</li> </ul>

Name	Function
12 [User] button	Select any frequently used item from the four available Configuration menu items, and assign it to this button. By pressing the [User] button, the assigned menu item selection/adjustment screen is displayed, allowing you to make one-touch settings/adjustments. ☛ "Settings Menu" p.60
13 [Page] buttons [+] [−]	These buttons cannot be used while projecting in a stacked configuration.
14 [E-Zoom] buttons [⊕] [⊖]	Enlarges or reduces the image without changing the projection size. ☛ "Enlarging Part of the Image (E-Zoom)" p.47
15 [A/V Mute] button	<ul style="list-style-type: none"> <li>Turns the video and audio on or off. ☛ "Hiding the Image and Sound Temporarily (A/V Mute)" p.45</li> <li>You can change the Projection mode as follows by pressing the button for about five seconds. <b>Front ↔ Front/Ceiling</b> <b>Rear ↔ Rear/Ceiling</b></li> </ul>
16 [Help] button	Displays and closes the Help screen which shows you how to deal with problems if they occur. ☛ "Using the Help" p.65
17 [Freeze] button	Images are paused or unpaused. ☛ "Freezing the Image (Freeze)" p.46
18 [Volume] buttons [⏮] [⏭]	[⏮] Decreases the volume. [⏭] Increases the volume. ☛ "Adjusting the Volume" p.37
19 [Pointer] button	This cannot be used while projecting in a stacked configuration.
20 [Esc] button	<ul style="list-style-type: none"> <li>Stops the current function.</li> <li>If pressed when the Configuration menu is displayed, it moves to the previous level. ☛ "Using the Configuration Menu" p.56</li> </ul>

Name	Function
21 [Color Mode] button	Each time the button is pressed, the Color Mode changes. ☛ "Selecting the Projection Quality (Selecting Color Mode)" p.37
22 [2D/3D] button	Each time the button is pressed, the mode changes to 2D or 3D. Change to 3D mode when a 3D signal is being input. If a 3D signal is input while in 2D mode, the image is projected in 2D.
23 [LAN] button	This cannot be used on the projector.
24 [USB] button	This cannot be used while projecting in a stacked configuration.
25 [Source Search] button	Changes to the next input source that is sending an image. ☛ "Automatically Detect Input Signals and Change the Projected Image (Source Search)" p.34
26 Remote control light-emitting area	Outputs remote control signals.



## Replacing the remote control batteries

If delays in the responsiveness of the remote control occur or if it does not operate after it has been used for some time, it probably means that the batteries are becoming flat. When this happens, replace them with new batteries. Have two AA size manganese or alkaline batteries ready. You cannot use other batteries except for the AA size manganese or alkaline.

### Attention

Make sure you read the following manual before handling the batteries.

 [Safety Instructions](#)

### 1 Remove the battery cover.

While pushing the battery compartment cover catch, lift the cover up.

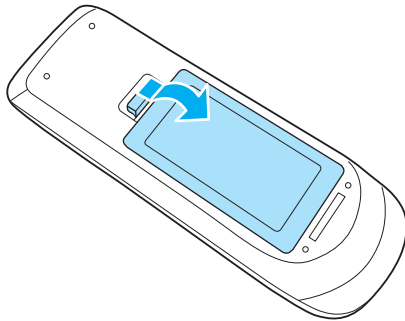

### 2 Replace the old batteries with new batteries.

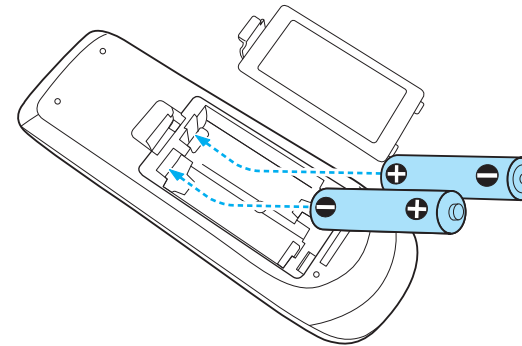

### Caution

Check the positions of the (+) and (-) marks inside the battery holder to ensure the batteries are inserted the correct way.

If the batteries are not used correctly, they could explode or leak causing a fire, injury, or damage to the product.

### 3 Replace the battery cover.

Press the battery compartment cover until it clicks into place.

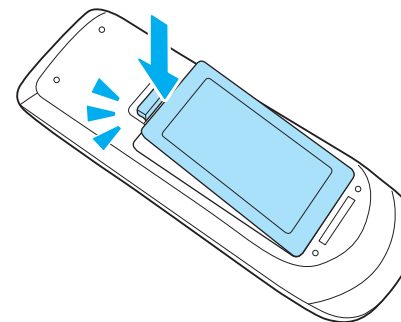

## Remote control operating range

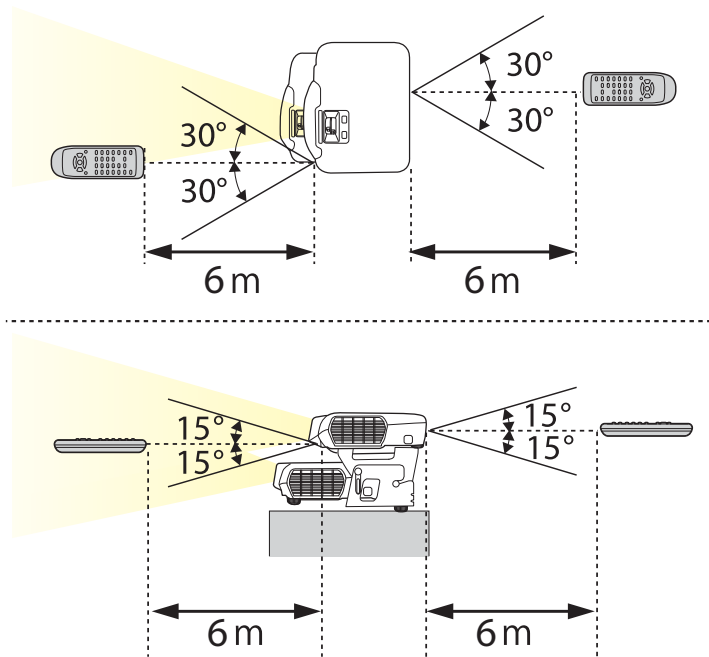



## Preparing the Projector

This chapter explains how to install the projector and connect projection sources.

## Installation Methods

Before installing, you first need to setup the top and bottom projectors. See the following manual for more information on setting up the projectors and the installation methods.

### [Startup Guide](#)

The projector supports the following four different projection methods. Install the projector according to the conditions of the installation location.

- Project images from in front of the screen. (Front projection)

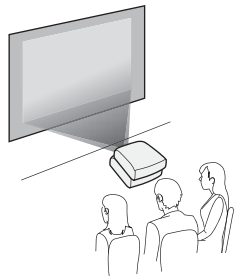

- Project images from behind a translucent screen. (Rear projection)

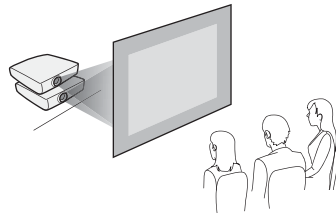

- Suspend the projectors from the ceiling and project images from in front of a screen. (Front/Ceiling projection)

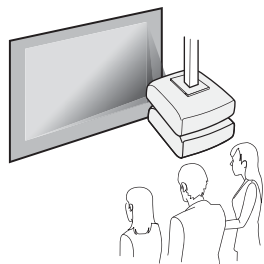

- Suspend the projectors from the ceiling and project images from behind a translucent screen. (Rear/Ceiling projection)

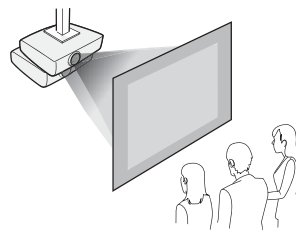



### **Warning**

- A special method of installation is required when suspending the projector from a ceiling (ceiling mount). If it is not installed correctly, it could fall causing an accident and injury.
- If you use adhesives on the Ceiling mount fixing points to prevent the screws from loosening, or if you use things such as lubricants or oils on the projector, the projector case may crack causing it to fall from its ceiling mount. This could cause serious injury to anyone under the ceiling mount and could damage the projector.  
When installing or adjusting the ceiling mount, do not use adhesives to prevent the screws from loosening and do not use oils or lubricants and so on.
- Do not cover the projector's air intake vent or air exhaust vent. If either of the vents are covered, the internal temperature could rise and cause a fire.

### **Attention**

Do not use the projector on its side. This may cause malfunctions to occur.



- You cannot view 3D images when projecting onto a rear screen. To view 3D images, project onto the front of a silver screen designed for passive 3D images.  
 ["Optional Accessories" p.94](#)
- An optional Ceiling mount is required when suspending the projector from a ceiling.  
 ["Optional Accessories" p.94](#)
- The default Projection setting is **Front**. You can change from **Front** to **Rear** from the Configuration menu.  
 [Extended - Projection p.61](#)
- You can change the Projection mode as follows by pressing down the [A/V Mute] button on the remote control for about five seconds.  
**Front ↔ Front/Ceiling**  
**Rear ↔ Rear/Ceiling**

The port name, location, and connector orientation differ depending on the source being connected.

## Connecting the Commander and the Receiver

To allow the commander to control receiver operations, you need to connect the commander and the receiver with a USB cable.

Connect the commander's USB(TypeA) port to the receiver's USB(TypeB) port with a USB cable.



In a configuration such as the illustration below, the projector on top is the commander, and the projector on the bottom is the receiver. When suspended from a ceiling, the projector on top is the receiver, and the projector on the bottom is the commander.

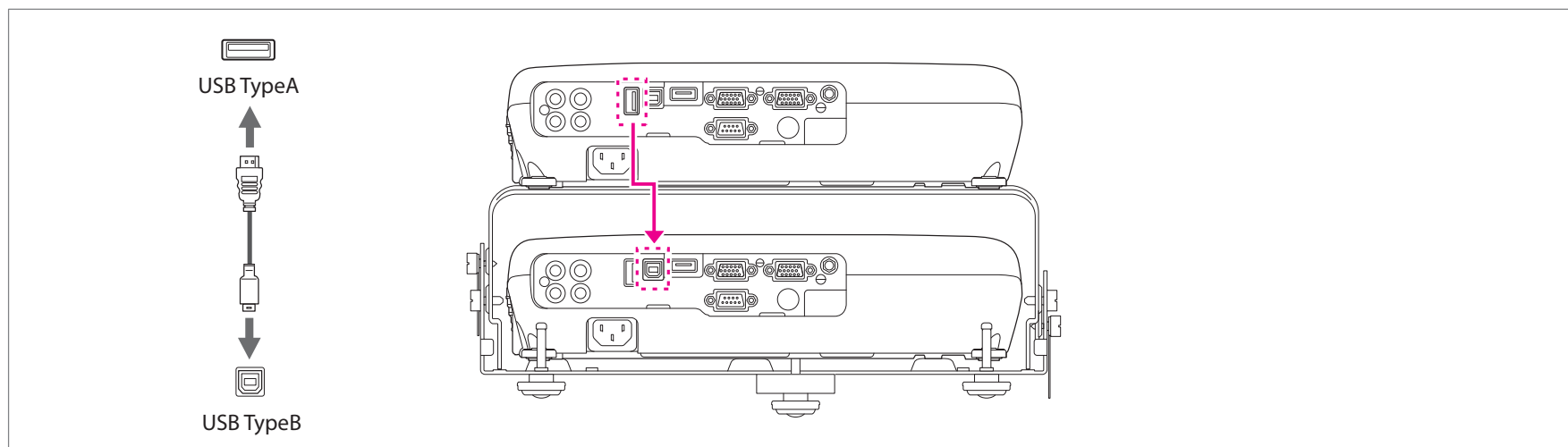

## Connecting a Computer

### Connecting with computer cables



Prepare the following items in advance.

- USB cable (supplied)
- Computer cables (available in local stores x3)
- Splitter that supports the computer cable (available in local stores)
- Audio cable (available in local stores) \*When outputting audio

- 1 Connect the commander's USB(TypeA) port to the receiver's USB(TypeB) port with a USB cable.
- 2 Connect the splitter to the computer's display output port with a computer cable.  
Connect the Computer1 ports for the commander and the receiver to the splitter with computer cables.
- 3 Connect the projector's Audio-L/R port (commander or receiver) to the computer's audio out port with an audio cable. Audio is output from the connected projector.

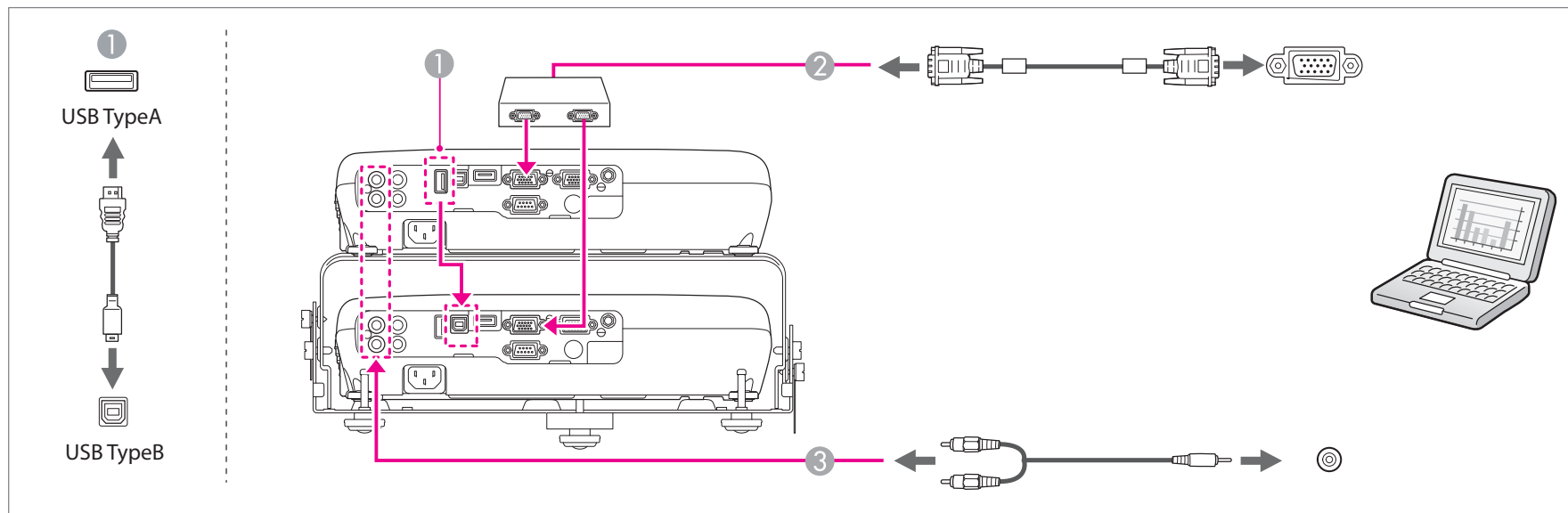



Follow the steps below when connecting without a splitter.

- Connect the computer's display output port to the commander's Computer1 port with a computer cable.
- Connect the commander's Monitor Out/Computer2 port and the receiver's Computer1 port with a computer cable.

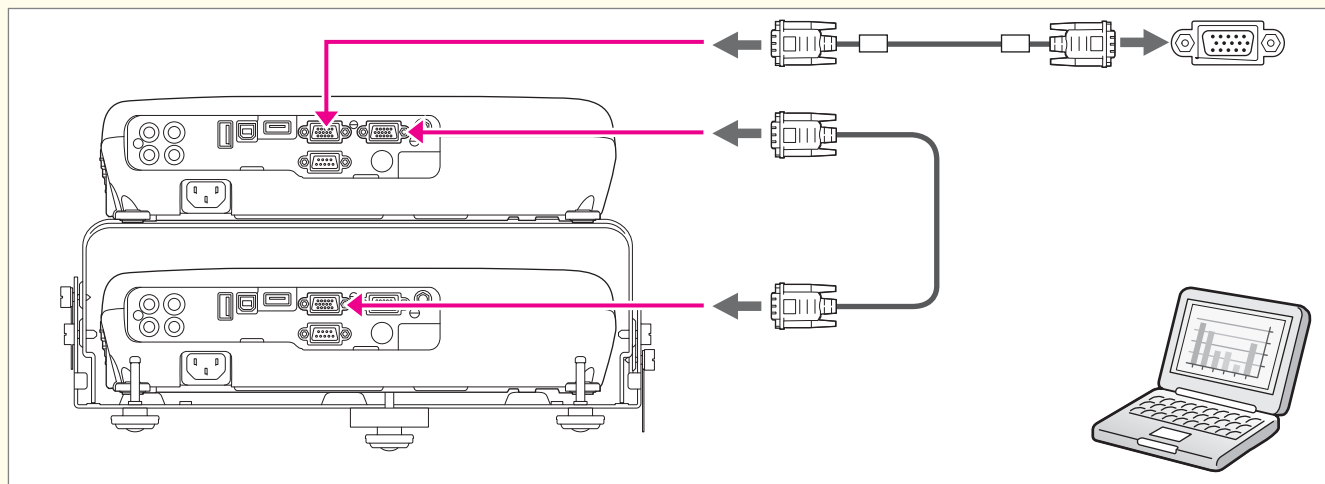

You need to set **Monitor Out Port** to **Monitor Out** from the Configuration menu.

☛ **Extended - Operation - Monitor Out Port** [p.61](#)

## Connecting with HDMI cables



Prepare the following items in advance.

- USB cable (supplied)
- HDMI cables (available in local stores x3)
- Splitter that supports HDMI (available in local stores)

- 1 Connect the commander's USB(TypeA) port to the receiver's USB(TypeB) port with a USB cable.
- 2 Connect the computer's HDMI port and the splitter with an HDMI cable.  
Connect the HDMI port for the commander and the receiver to the splitter with HDMI cables.  
You can send the computer's audio with the projected image.

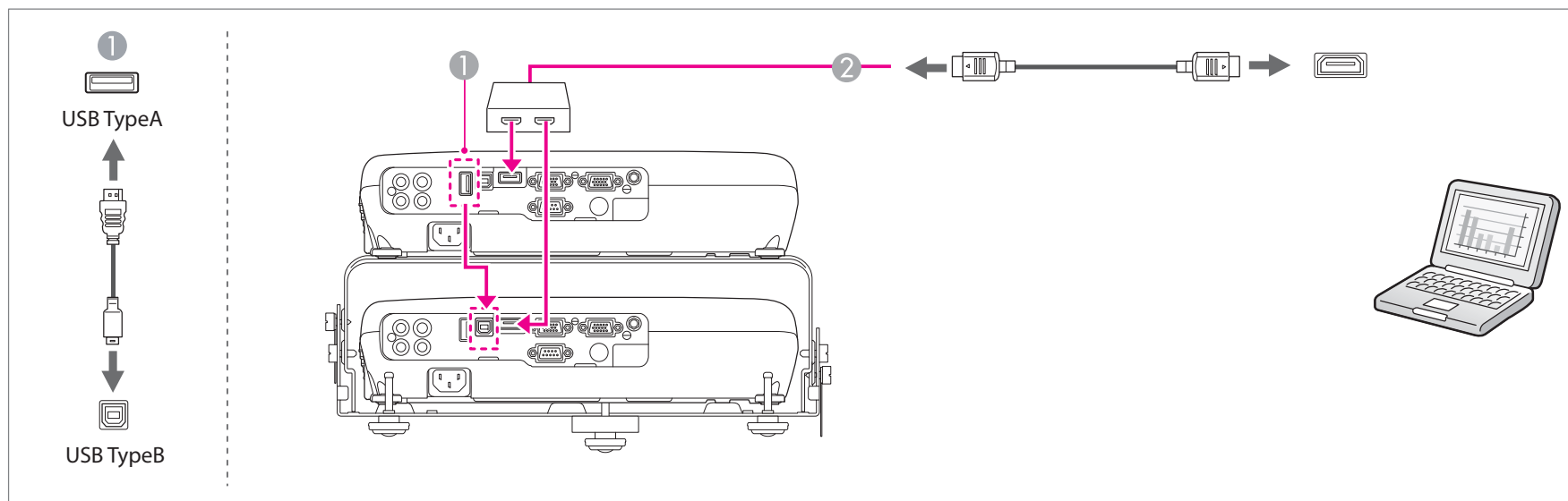



## Connecting Image Sources

You can connect DVD players, Blu-ray disc players, game consoles, and so on. When connecting a 3D device and projecting 3D content, connect using an HDMI cable and HDMI splitter that support 3D signals.

### Connecting with HDMI cables



Prepare the following items in advance.

- USB cable (supplied)
- HDMI cables (available in local stores x3)
- Splitter that supports HDMI (available in local stores)

- ① Connect the commander's USB(TypeA) port to the receiver's USB(TypeB) port with a USB cable.
- ② Connect the video equipment's HDMI port and the splitter with an HDMI cable.  
Connect the HDMI ports for the commander and the receiver to the splitter with HDMI cables.  
You can send the image source's audio with the projected image.

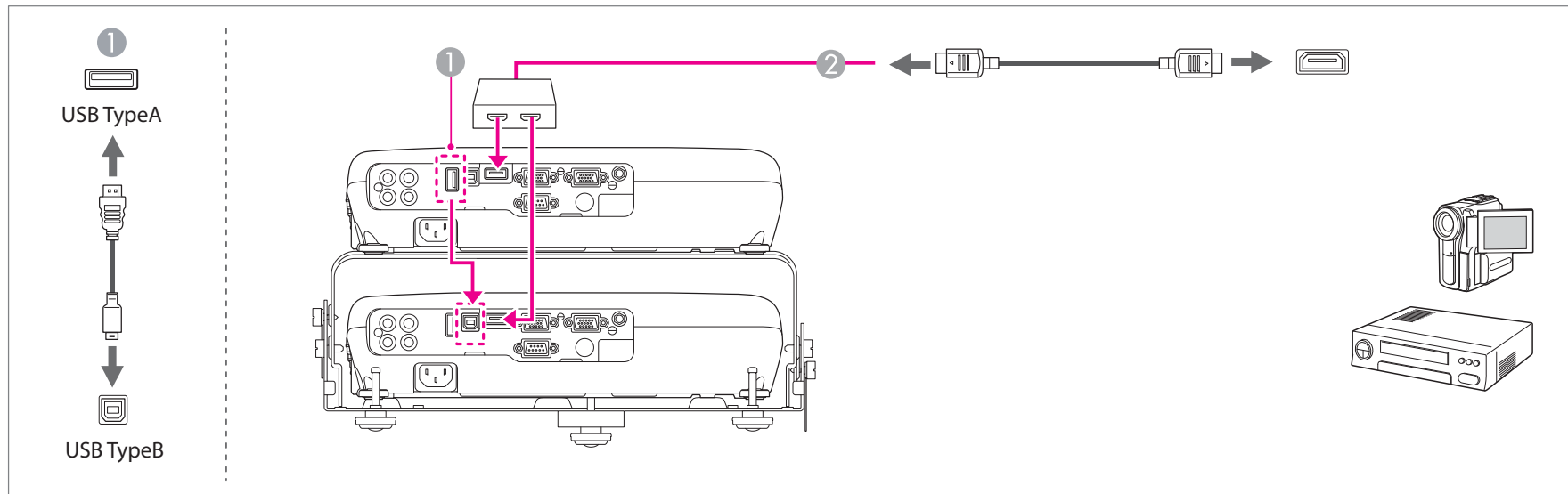

## Connecting with video cables



Prepare the following items in advance.

- USB cable (supplied)
- Video cables (available in local stores x3)
- Splitter that supports the video signal (available in local stores)
- Audio cable (available in local stores) \*When outputting audio

- 1 Connect the commander's USB(TypeA) port to the receiver's USB(TypeB) port with a USB cable.
- 2 Connect the splitter to the video equipment's video output port with a video cable.  
Connect the Video ports for the commander and the receiver to the splitter with video cables.
- 3 Connect the projector's Audio-L/R port (commander or receiver) to the video equipment's audio out port with an audio cable. Audio is output from the connected projector.

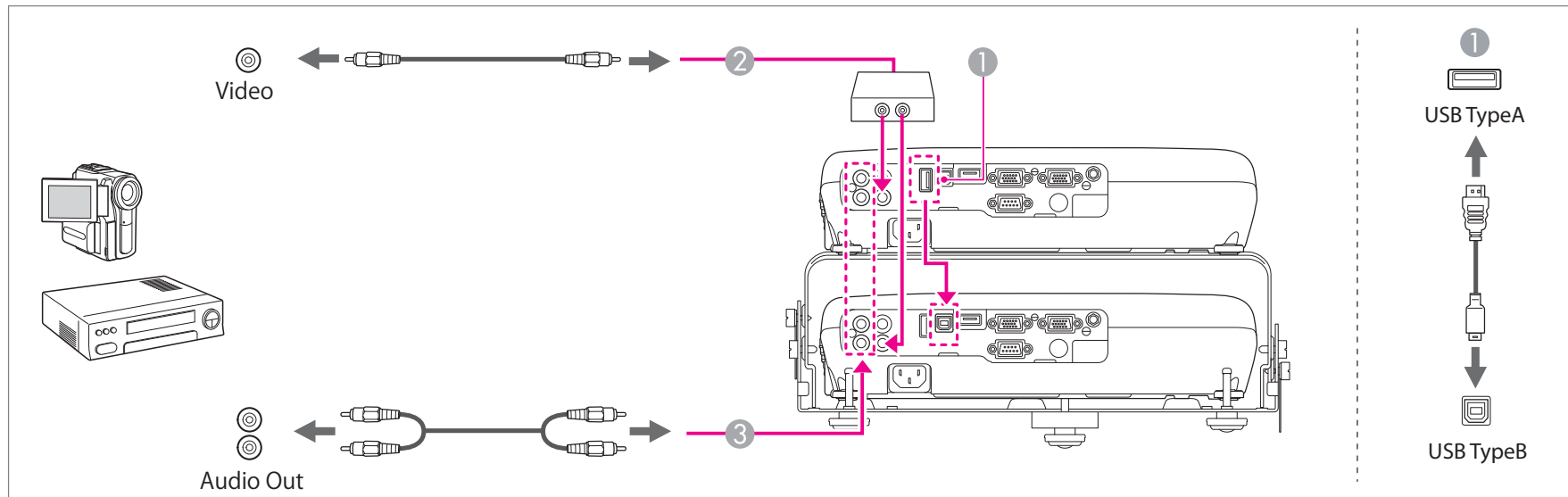

## Connecting with S-video cables



Prepare the following items in advance.

- USB cable (supplied)
- S-video cables (available in local stores x3)
- Splitter that supports the S-video signal (available in local stores)
- Audio cable (available in local stores) \*When outputting audio

- 1 Connect the commander's USB(TypeA) port to the receiver's USB(TypeB) port with a USB cable.
- 2 Connect the splitter to the video equipment's S-video output port with an S-video cable.  
Connect the S-Video ports for the commander and the receiver to the splitter with S-video cables.
- 3 Connect the projector's Audio-L/R port (commander or receiver) to the video equipment's audio out port with an audio cable. Audio is output from the connected projector.

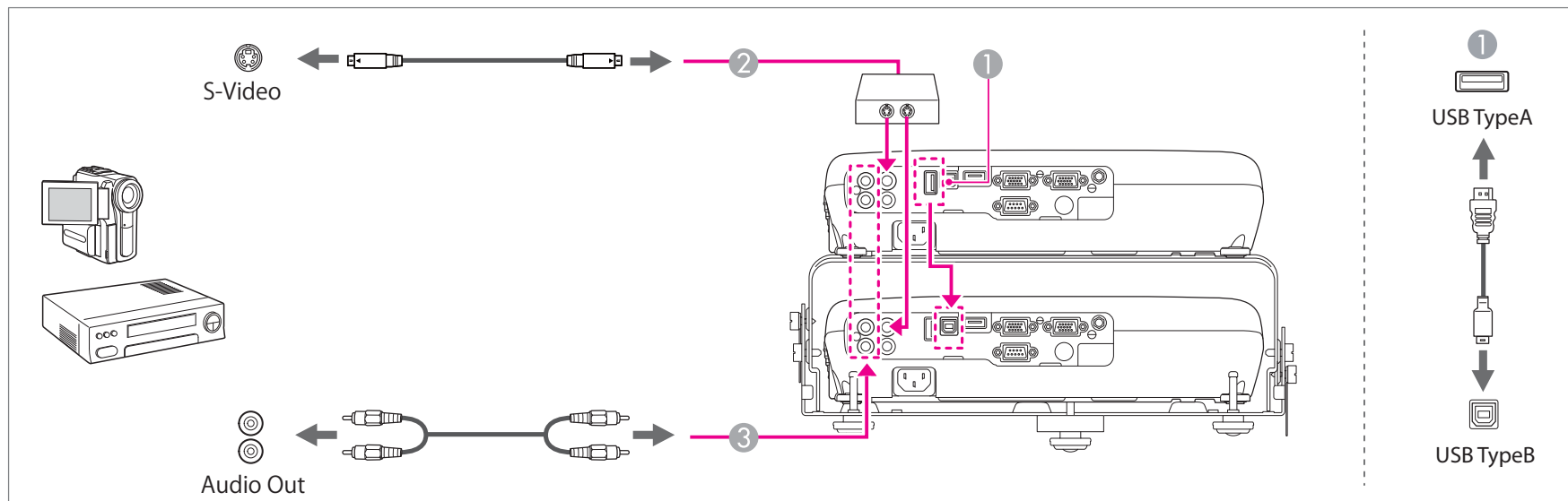

## Connecting with component video cables



Prepare the following items in advance.

- USB cable (supplied)
- Component video cable (available in local stores)
- Computer cables (available in local stores x2)
- Splitter that supports the component video signal (available in local stores)
- Audio cable (available in local stores) \*When outputting audio

- 1 Connect the commander's USB(TypeA) port to the receiver's USB(TypeB) port with a USB cable.
- 2 Connect the splitter to the video equipment's component output port with a component cable.  
Connect the Computer1 ports for the commander and the receiver to the splitter with computer cables.
- 3 Connect the projector's Audio-L/R port (commander or receiver) to the video equipment's audio out port with an audio cable. Audio is output from the connected projector.

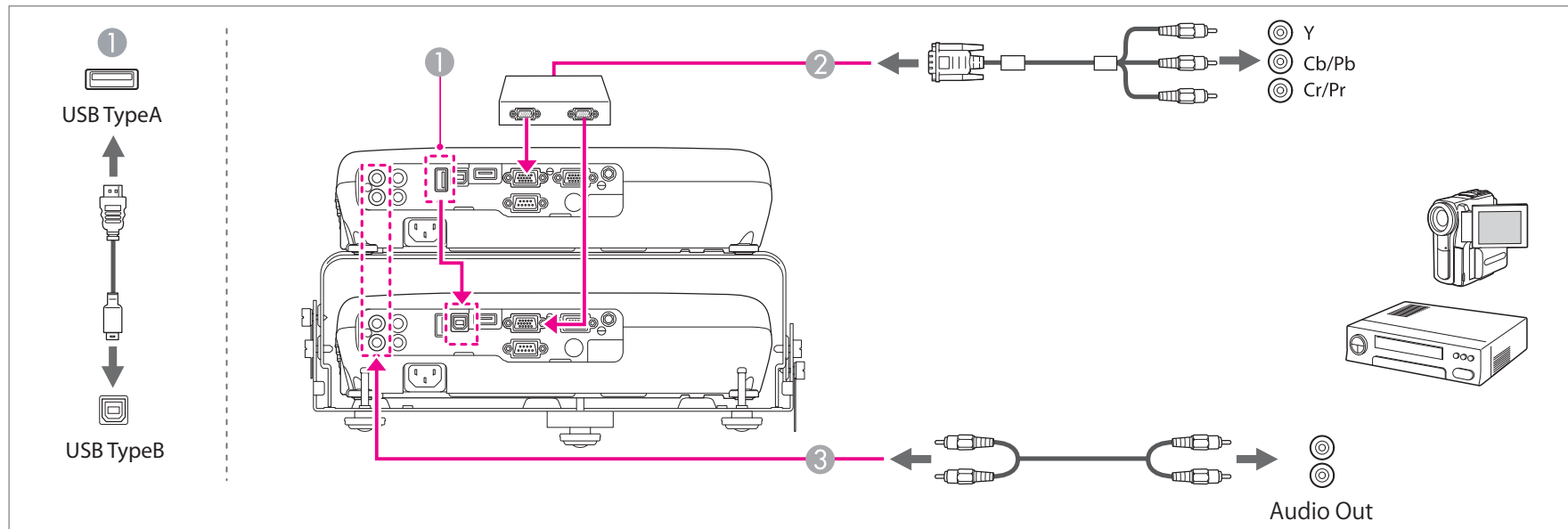

## Attention

- If the input source is on when you connect it to the projector, it could cause a malfunction.
- If the orientation or shape of the plug differs, do not try to force it in. The device could be damaged or could malfunction.



- If the source you want to connect to has an unusually shaped port, use the cable supplied with the device or an optional cable to connect to the projectors.
- When using a commercially available 2RCA(L/R)/stereo mini-pin audio cable, make sure it is labeled "No resistance".

## Connecting External Equipment

You can output images and audio by connecting an external monitor or speaker.

### ① When outputting images to an external monitor

Connect the Monitor Out/Computer2 port for the commander or receiver to an external monitor.

### ② When outputting audio to an external speaker

Connect the Audio Out port for the commander or receiver to an external speaker.

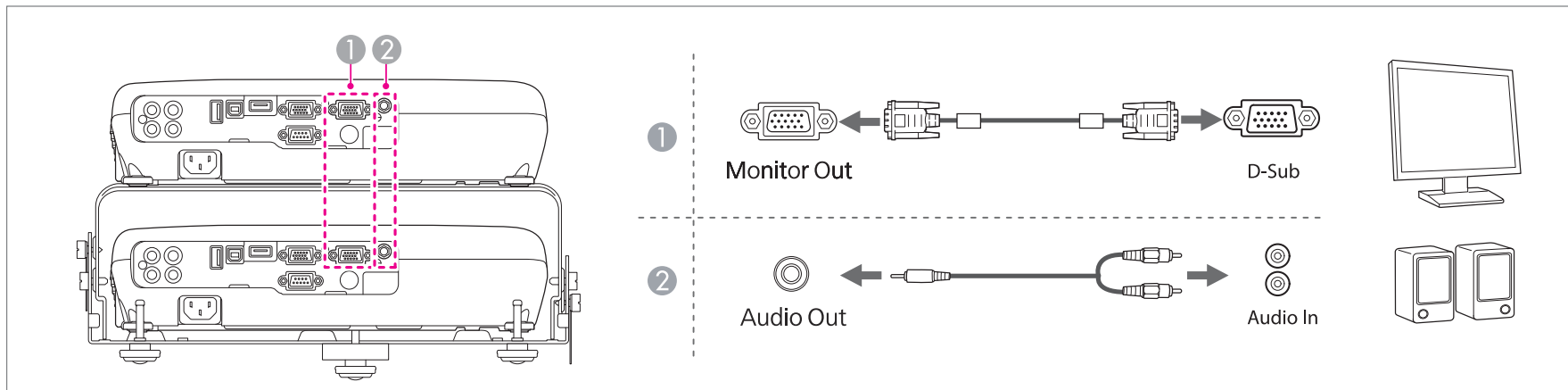



- When outputting images to an external monitor, set **Monitor Out Port** to **Monitor Out** from the Configuration menu.

☛ **Extended - Operation - Monitor Out Port** [p.61](#)

- Only analog RGB signals from the Computer port can be output to an external monitor. You cannot output signals input from other ports or component video signals.
- Setting gauges for functions such as Keystone, Configuration Menu, or Help screens are not output to the external monitor.
- When the audio cable jack is inserted into the Audio Out port, audio stops being output from the projector's built-in speakers and switches to external output.



## Basic Usage

This chapter explains how to project and adjust images.

## From Installation to Projection

This section explains the procedure for connecting the projectors to a computer with the computer cable and projecting images.

Follow the steps in the manual below to setup the commander and receiver in a stacked configuration.

### *Startup Guide*



When setup on a surface such as a desk, the projector on top is the commander, and the projector on the bottom is the receiver. When suspended from a ceiling, the projector on top is the receiver, and the projector on the bottom is the commander.

- 1** Connect the projectors (commander and receiver) to an electrical outlet with the power cords.

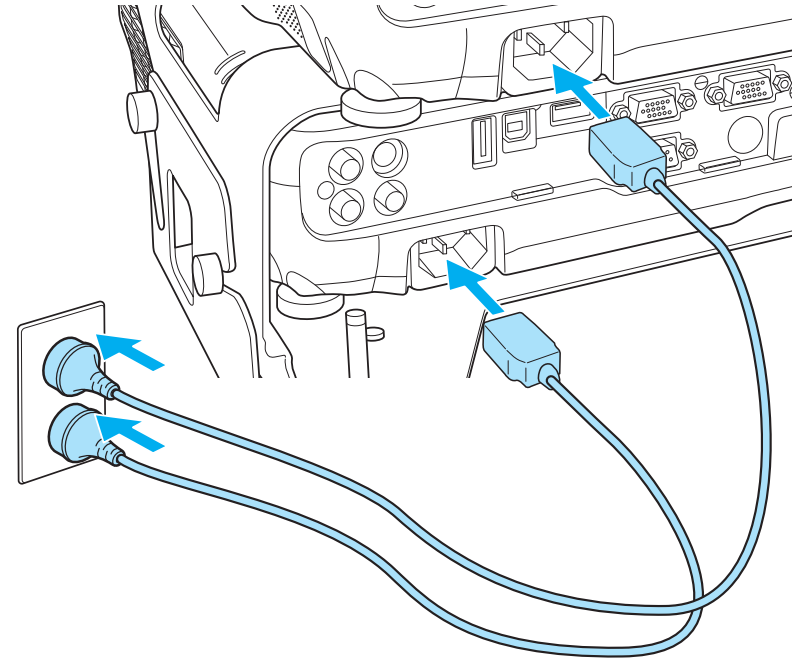

- 2** Connect the commander's USB(TypeA) port to the receiver's USB(TypeB) port with a USB cable.

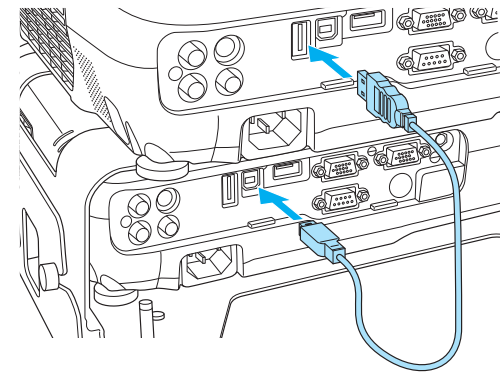

- 3** Connect the splitter to the computer's display output port with a computer cable.



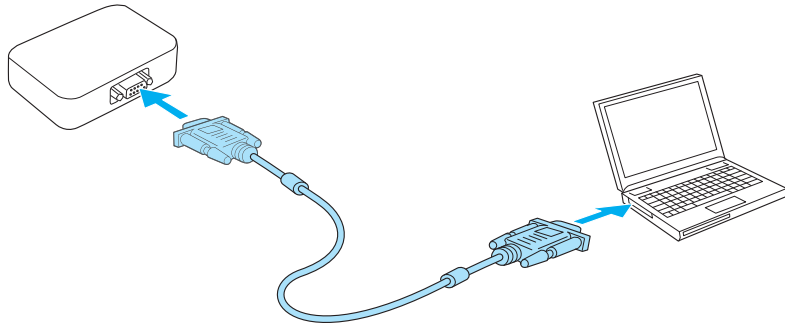

**4** Connect the Computer1 ports for the commander and the receiver to the splitter with computer cables.

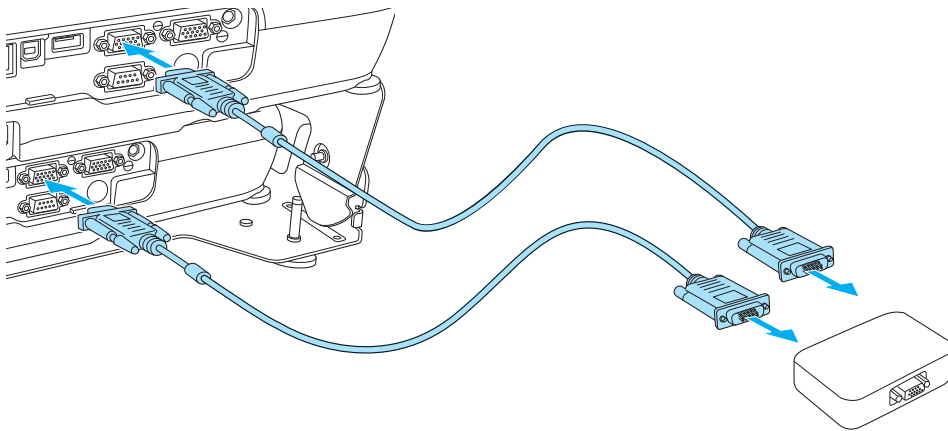

**5** Open the A/V mute slide for the commander and the receiver.

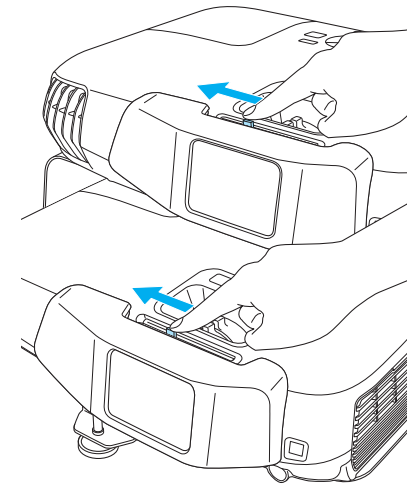

**6** Press the [⏻] button on the commander's control panel or remote control.

Using the remote control

Using the control panel

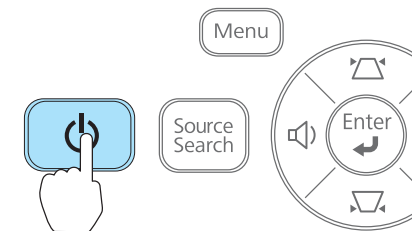
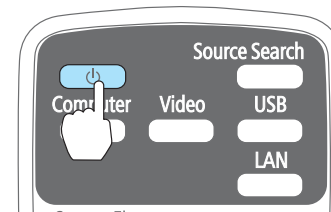



The commander and the receiver turn on.

**7** Superimpose two images.  
See the following manual for details.

[Startup Guide](#)

**8** Turn on your computer.

- 9** Change the computer's screen output.  
 When using a laptop computer, you need to change the screen output from the computer. Hold down the Fn key (function key), and press the  key.

 • The method for changing differs depending on the computer being used. See the documentation supplied with the computer.  
 • When turning off the projectors, press the commander's [P] button on the control panel or remote control twice.

If the image is not projected, you can change the projected image using one of the following methods.

- Press the [Source Search] button on the commander's control panel or remote control.
  - ☛ "Automatically Detect Input Signals and Change the Projected Image (Source Search)" [p.34](#)
- Press the button for the target port on the remote control.
  - ☛ "Switching to the Target Image by Remote Control" [p.35](#)

 See the following when one of the projectors is not turned on, or if you want to turn on only one of the projectors.

- ☛ "One of the projectors is not turned on, or the projectors have not been linked together" [p.78](#)
- ☛ "Turning On One Projector in a Stacked Configuration" [p.91](#)

## Automatically Detect Input Signals and Change the Projected Image (Source Search)

Press the [Source Search] button to project images from the port currently receiving an image.

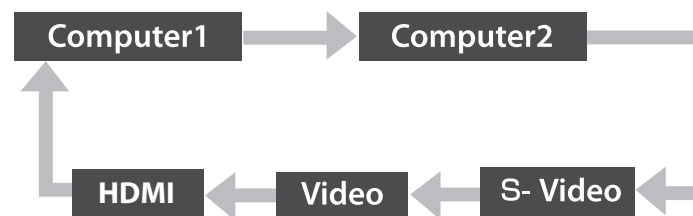
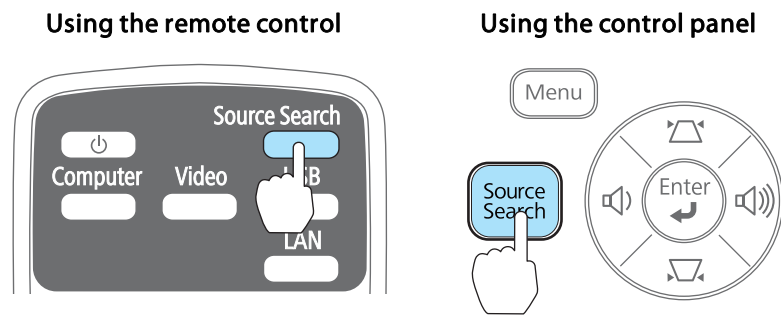

\*Computer2 is only available when **Monitor Out Port** is set to **Computer2** from the Configuration menu.

When two or more image sources are connected, press the [Source Search] button until the target image is projected.

When your video equipment is connected, start playback before beginning this operation.



The following screen is displayed while no image signals are input.

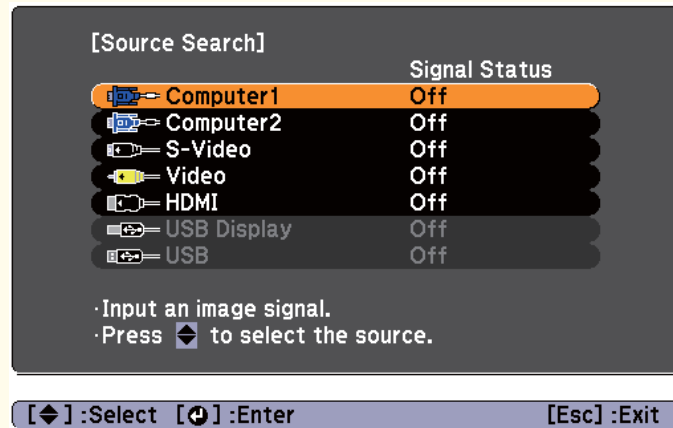

## Switching to the Target Image by Remote Control

You can change directly to the target image by pressing the following buttons on the remote control.

Remote control

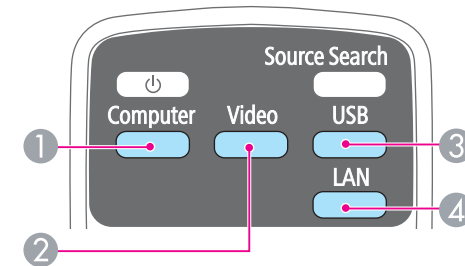

- ① Switches to the image from the device connected to Computer1 or Computer2.
- ② Each time the button is pressed, it cycles through the images being input from the following sources.
  - S-Video port
  - Video port
  - HDMI port
- ③ This cannot be used while projecting in a stacked configuration.
- ④ This cannot be used on the projector.

## Superimposing Two Images

If the images shift out of sync during projection, press the [Screen Fit] button on the commander or the remote control. The adjustment screen is displayed and the images are superimposed correctly after a few seconds.

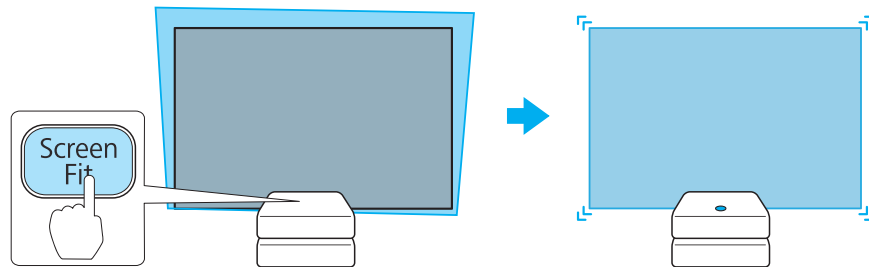

See the following manual for more information on superimposing two images after installation.

[Startup Guide](#)

## Adjusting the Image Size

You can adjust the size of the image by using the zoom rings on the commander and the receiver. See the following manual for more information on matching the size for two images.

[Startup Guide](#)

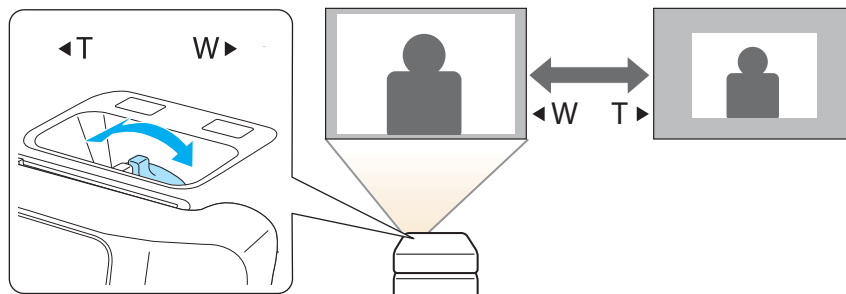

## Adjusting the Image Position

Extend or retract the front adjustable foot for the stacker mount. You can adjust the position of the image by tilting the projector up to 6 degrees.

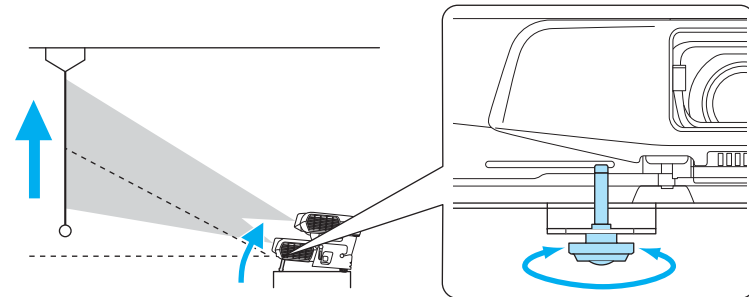

The larger the angle of tilt, the harder it becomes to focus. Install the projector so that it only needs to be tilted at a small angle.

## Adjusting the Horizontal Tilt

Extend and retract the rear feet for the stacker mount to adjust the horizontal tilt.

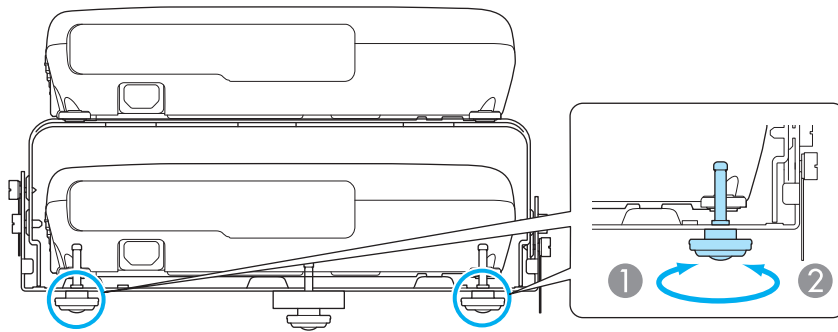

- ① Extend the rear foot.
- ② Retract the rear foot.

## Correcting the Focus

You can adjust the focus of the image by using the focus rings on the commander and the receiver.

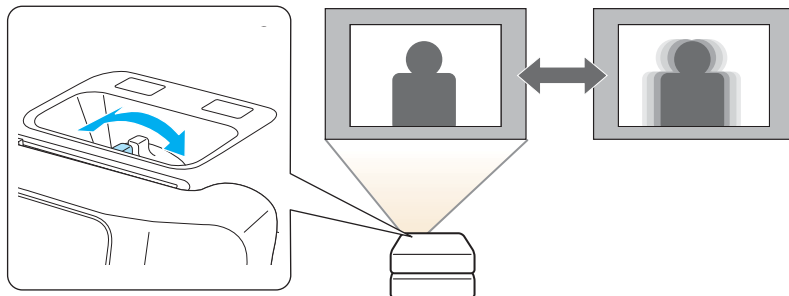

## Adjusting the Volume

You can adjust the volume using one of the following methods.

- Press the [Volume] button on the control panel or the remote control to adjust the volume.
  - [<] Decreases the volume.
  - [>] Increases the volume.

### Using the remote control

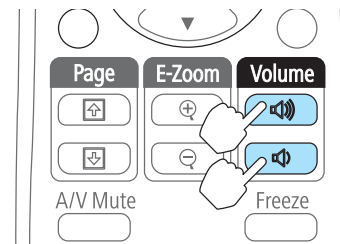

### Using the control panel

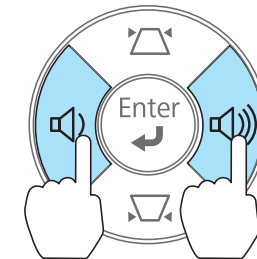

- Adjust the volume from the Configuration menu.
  - ☛ **Settings - Volume** [p.60](#)

### Caution

Do not start at high volume.  
A sudden excessive volume may cause loss of hearing. Always lower the volume before powering off, so that you can power on and then gradually increase the volume.

## Selecting the Projection Quality (Selecting Color Mode)

Sets the color mode according to the surroundings. The brightness of the image varies depending on the color mode selected.

## When a 2D signal is being input

Mode	Application
<b>Dynamic</b>	Ideal for use in a bright room. This is the brightest mode, and reproduces shadow tones well.
<b>Presentation</b>	Ideal for making presentations using color materials in a bright room.
<b>Theatre</b>	Ideal for watching films in a dark room. Gives images a natural tone.
<b>Photo*1</b>	Ideal for projecting still pictures, such as photos, in a bright room. The images are vivid and brought into contrast.
<b>Sports*2</b>	Ideal for watching TV programmes in a bright room. The images are vivid and brought to life.
<b>sRGB</b>	Ideal for images that conform to the <a href="#">sRGB</a> color standard.
<b>Blackboard</b>	Even if you are projecting onto a blackboard (greenboard), this setting gives your images a natural tint, just like when projecting onto a screen.
<b>Whiteboard</b>	Ideal for making presentations using a whiteboard.

\*1 This can only be selected when an RGB signal is being input.



\*2 This selection is only available when the input signal is component video, or when the input source is Video or S-Video.

## When a 3D signal is being input

Mode	Application
<b>Dynamic</b>	Ideal for use in a bright room. This is the brightest mode, and reproduces shadow tones well.
<b>3D Presentation</b>	Ideal for making presentations using color materials in a bright room.
<b>3D Theatre</b>	Ideal for watching films in a dark room. Gives images a natural tone.

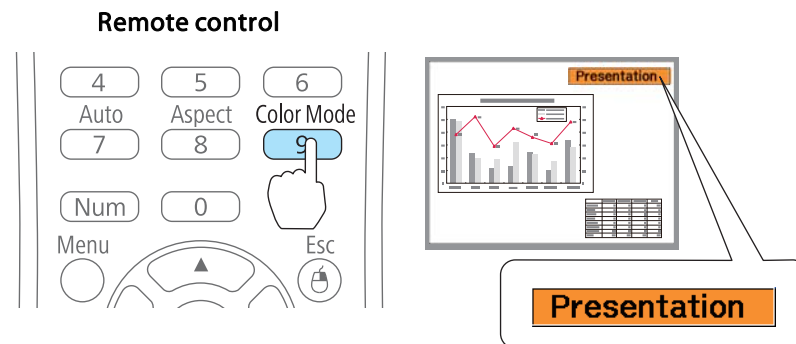
Each time you press the [Color Mode] button, the Color Mode name is displayed on the screen and the Color Mode changes.



 You can set Color Mode from the Configuration menu.  
 **Image - Color Mode** [p.58](#)

## Setting Auto Iris

By automatically setting the luminance according to the brightness of the displayed image, it lets you enjoy deep and rich images.

**1** Press the [Menu] button.

 "Using the Configuration Menu" [p.56](#)

### Using the remote control

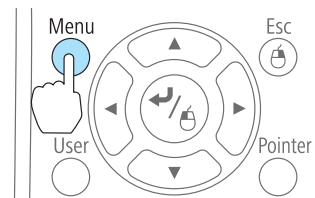

### Using the control panel

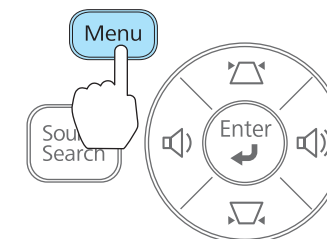

**2** Select **Auto Iris** from **Image**.

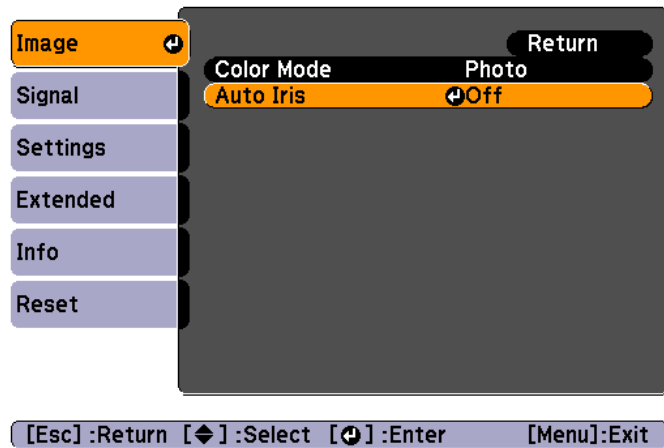

**3** Select **On**.

The setting is stored for each Color Mode.

**4** Press the [Menu] button to finish making settings.



Auto Iris can only be set when the **Color Mode** is **Dynamic**, **Theatre**, or **3D Theatre**.

## Changing the Aspect Ratio of the Projected Image

You can change the Aspect Ratio of the projected image to suit the type, the ratio of height and width, and the resolution of the input signals.

Available aspect modes vary depending on the image signal currently being projected.

## Changing methods

Each time you press the [Aspect] button on the remote control, the aspect mode name is displayed on the screen and the aspect ratio changes.

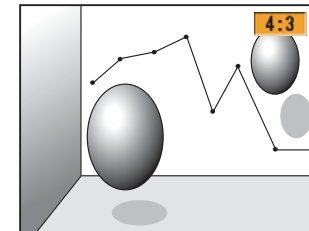
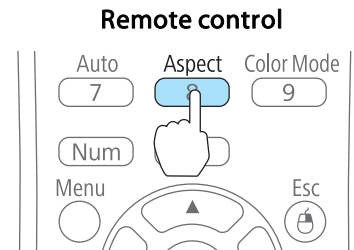

- You can set the aspect ratio from the Configuration menu.
- Signal - Aspect p.58**
- In 3D mode, the aspect mode is set to **Normal**.

## Changing the aspect mode

Projecting images from video equipment or from the HDMI port

Each time the [Aspect] button is pressed, the aspect mode changes in the order **Normal** or **Auto**, **16:9**, **Full**, **Zoom**, and **Native**.

Example: 1080p signal input (resolution: 1920x1080, aspect ratio: 16:9)

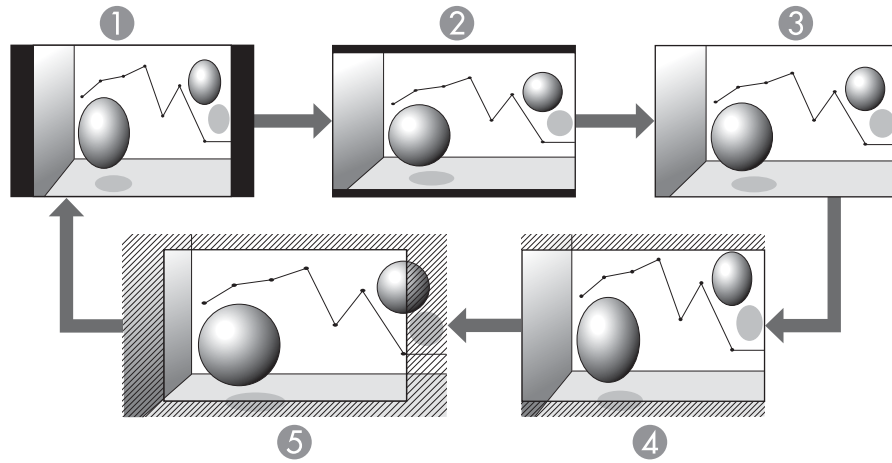

- ① Normal or Auto
- ② 16:9
- ③ Full
- ④ Zoom
- ⑤ Native

Projecting images from a computer

The following shows projection examples for each aspect mode.

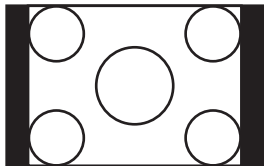
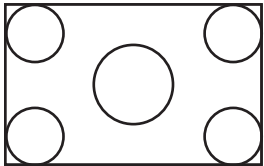
Aspect Mode	Input Signal	
	XGA 1024X768(4:3)	WXGA 1280X800(16:10)
<b>Normal</b>		

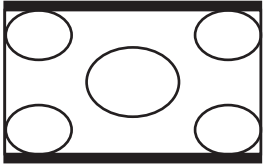
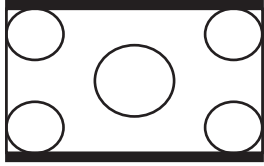
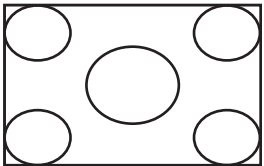
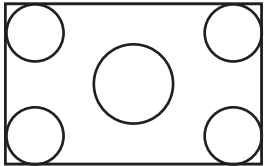
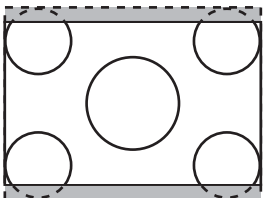
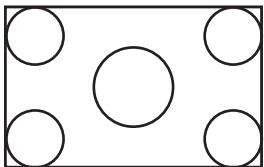
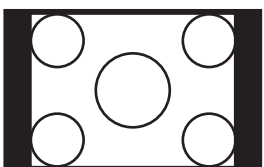
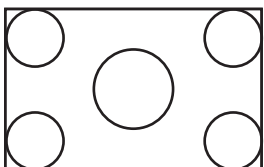
Aspect Mode	Input Signal	
	XGA 1024X768(4:3)	WXGA 1280X800(16:10)
<b>16:9</b>		
<b>Full</b>		
<b>Zoom</b>		
<b>Native</b>		



If parts of the image are missing, set the **Resolution** setting to **Wide** or **Normal** from the Configuration menu, according to the size of the computer panel.

☛ **Signal - Resolution** [p.58](#)





# Useful Functions

This chapter explains useful tips for giving presentations, and the Security functions.

## Projecting 3D Images

You can connect devices that support 3D playback, such as 3D Blu-ray discs and 3D games, and enjoy stunning 3D images.

### Preparing to view 3D images

Make the following preparations before viewing 3D images.

- Attach the polarizers
  - ☛ [Startup Guide](#)
- Passive polarized 3D glasses  
Supplied or optional (ELPGS02A/ELPGS02B)  
See the User's Guide for the 3D Glasses for more information on the 3D Glasses.
- HDMI cables that supports 3D signals (available in local stores x3)
- HDMI splitter that supports 3D signals (available in local stores)
- Silver screen designed for passive 3D images (available in local stores)
- Make the following settings from the Configuration menu.
  - 3D Display: On
  - 3D Format: Auto or the same format as the 3D signal from the connected device
  - ☛ [Signal - 3D Setup p.58](#)

### Supported 3D signals

The projectors support the following 3D signals.

- Frame Packing
- Side by Side
- Top and Bottom

### Viewing methods for 3D images

- 1** Connect the commander and the receiver to a playback device with HDMI cables.



3D images can only be viewed when HDMI is being input. Prepare HDMI cables and an HDMI splitter that support 3D signals.

See the following for more information on connecting the HDMI cables.

- ☛ [Startup Guide](#)
- ☛ ["Connecting Equipment" p.21](#)

- 2** Turn on the playback device and the projectors, and then project the image.

See the following for more information on projecting images.

- ☛ ["From Installation to Projection" p.32](#)
- ☛ ["Switching to the Target Image by Remote Control" p.35](#)

- 3** Put on the 3D Glasses.

Enjoy the 3D images.

If you cannot view the 3D images, press the [2D/3D] button on the remote control. **3D Display On** is displayed on the projected screen.



- How a 3D image is perceived varies depending on the individual.
- If you cannot view the 3D effect correctly, perform **Inverse 3D Image** from the Configuration menu.
  - ☛ **Signal - 3D Setup - Inverse 3D Image** p.58
- How the 3D image is viewed may change depending on the temperature around the projectors and how long the lamps have been used. Refrain from using the projectors if the image is not projected normally.

## Warnings regarding viewing 3D images

Note the following important points when viewing 3D images.



### Warning

- Do not leave the 3D Glasses or the supplied parts within reach of children. They could be accidentally swallowed. If anything is accidentally swallowed, contact a doctor immediately.

## Viewing area for 3D images

When viewing 3D images, we recommend viewing from an angle of no more than 30° from the screen.

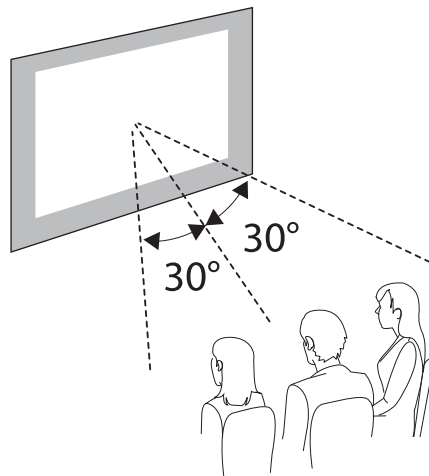

You can use screen sizes up to 120".

☛ "Screen Size and Projection Distance" p.96

## Cautions regarding using 3D Glasses

### **Caution**

- Be careful of the edges of the frame when wearing the 3D Glasses. If they poke your eye and so on, an injury could occur.
- Do not place your finger in any of the moving sections (such as the hinges) of the 3D Glasses. Otherwise an injury could occur.
- When disposing of the 3D Glasses, follow your local rules and regulations.
- Make sure you wear the 3D Glasses correctly. Do not wear the 3D Glasses upside down. If the image is not displayed correctly, it could cause you to feel unwell.
- Do not wear the glasses unless you are viewing a 3D image.
- Do not use the 3D Glasses as sunglasses.
- How a 3D image is perceived varies depending on the individual. Stop using the 3D function if you feel strange or cannot see in 3D. Continuing to view the 3D images could cause you to feel unwell.
- Stop wearing the 3D Glasses immediately if they seem abnormal or a malfunction occurs. Continuing to view the 3D images could cause you harm and to feel unwell.
- Stop wearing the 3D Glasses if your ears, nose, or temples become red, painful, or itchy. Continuing to view the 3D images could cause you to feel unwell.
- Stop wearing the 3D Glasses if your skin feels unusual when wearing the glasses. The paint or materials used in the 3D Glasses could cause an allergic reaction.

## Cautions when viewing images

### **Caution**

- When viewing 3D images, always take periodic breaks during extended viewing. Long periods of viewing 3D images may cause eye fatigue.
- The necessity and timing of breaks varies from person to person. If your eyes still feel tired or uncomfortable even after taking a break from viewing, stop viewing immediately.

## Cautions regarding viewing methods

### **Caution**

- If your eyes feel fatigued or uncomfortable when viewing 3D images, stop viewing immediately. Continuing to view the 3D images could cause you to feel unwell.
- When viewing 3D images be sure to always wear 3D Glasses. Do not attempt to view 3D images without 3D Glasses. Doing so could cause you to feel unwell.
- Do not place any breakable or fragile objects around you when using 3D Glasses. 3D images may cause you to move your body involuntarily, resulting in damage to nearby items or personal injury.
- Only wear 3D Glasses when viewing 3D images. Do not move around while wearing 3D Glasses. Your vision may appear darker than normal, causing you to fall or injure yourself.
- View from in front of the screen. Viewing 3D images at an angle reduces the 3D effect and may cause you to feel unwell due to unintended color changes.
- Stay at least three times the height of the screen away from the screen when viewing 3D images. The recommended viewing distance for an 80-inch screen is at least 3 meters, and at least 3.6 meters for a 100-inch screen. Sitting or standing any closer than the recommended viewing distance may result in eye fatigue.

## Cautions for the viewer

### **Caution**

You should not use 3D Glasses if you are sensitive to light, have a heart condition, or are unwell. Doing so could aggravate your pre-existing conditions.

## Cautions regarding the viewing age (for children)

### **Caution**

- The minimum recommended age to view 3D images is six years old.
- Children under the age of six are still developing and viewing 3D images may cause complications. Consult your doctor if you have any concerns.
- Children viewing 3D images through 3D Glasses should always be accompanied by an adult.

It is often difficult to tell when a child is feeling tired or uncomfortable, which could result in them feeling suddenly unwell. Always check that children in your care are not experiencing any eye fatigue during viewing.

## Hiding the Image and Sound Temporarily (A/V Mute)

You can use this when you want to focus the audience's attention on what you are saying, or if you do not want to show details such as when you are changing between files during presentations from a computer.

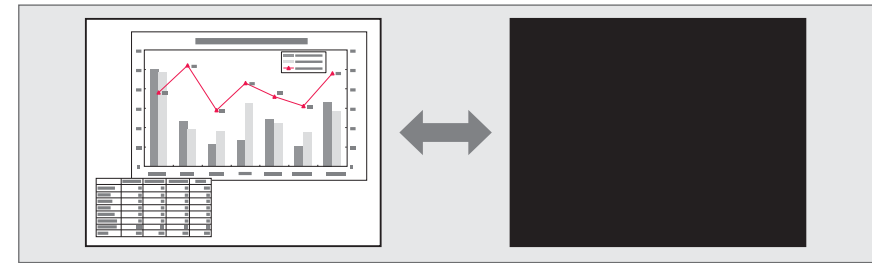

Each time you press the [A/V Mute] button or open/close the lens cover, A/V Mute turns on or off.

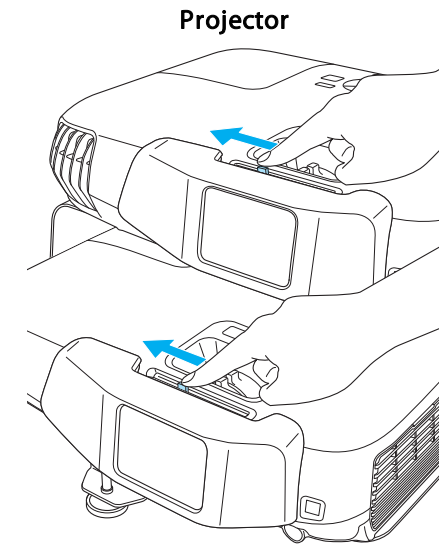
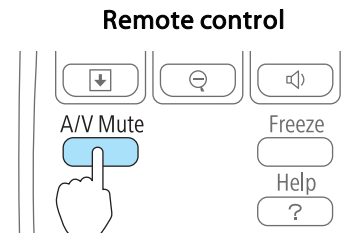



- When projecting moving images, the images and sound continue to be played back while A/V Mute is on. It is not possible to resume projection from the point where A/V Mute was activated.
- You can select the screen displayed when the [A/V Mute] button is pressed from the Configuration menu.
  - ☛ **Extended - Display - A/V Mute p.61**
- When the A/V mute slide is closed for approximately 30 minutes, Lens Cover Timer activates and the power is automatically turned off. If you do not want Lens Cover Timer to activate, set **Lens Cover Timer to Off**.
  - ☛ **Extended - Operation - Lens Cover Timer p.61**
- The lamp is still lit during A/V Mute, so the lamp hours continue to accumulate.



- Audio does not stop.
- When projecting moving images, the images continue to be played back while the screen is frozen. It is not possible to resume projection from the point where the screen was frozen.
- When frozen, superimposed images may slip out of sync.
- If the [Freeze] button is pressed while the Configuration menu or the Help screen is displayed, the menu or the Help screen that is displayed is closed.
- Freeze still works while E-Zoom is being used.

## Freezing the Image (Freeze)

When Freeze is activated on moving images, the frozen image continues to project on the screen, so you can project a moving image one frame at a time like a still photo. Also, you can perform operations such as changing between files during presentations from a computer without projecting any images if the Freeze function is activated beforehand.

Each time you press the [Freeze] button, Freeze turns on or off.

### Remote control

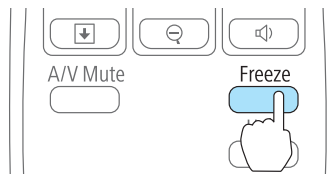

## Enlarging Part of the Image (E-Zoom)

This is useful when you want to expand images to see them in greater detail, such as graphs and tables.

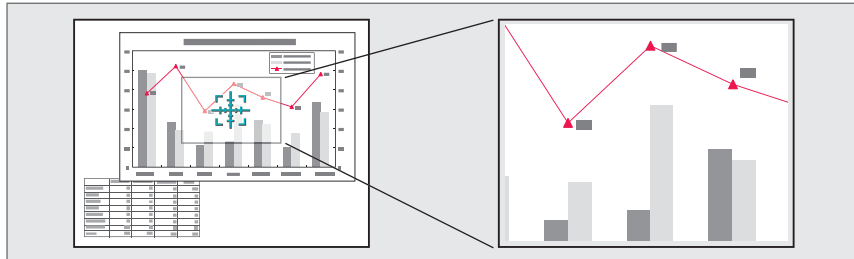

### 1 Start E-Zoom.

Press the [⊕] button to display the Cross (⊕).

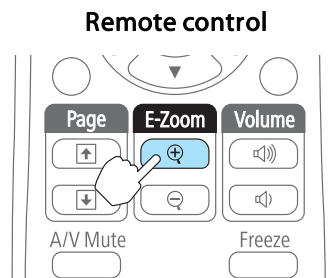

### 2 Move the Cross (⊕) to the area of the image that you want to enlarge.

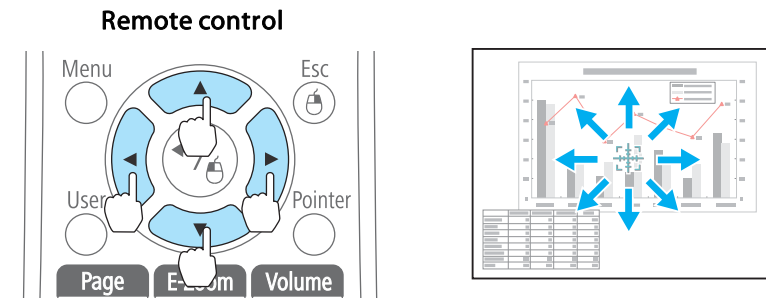

When any pair of adjacent [⤴], [⤵], [⤶], or [⤷] buttons are pressed at the same time, the pointer can be moved diagonally.

### 3 Enlarge.

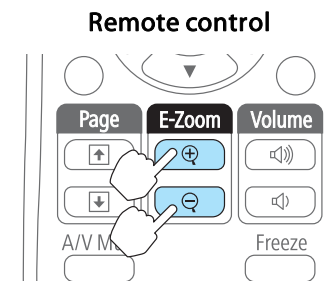

[⊕] button: Expands the area each time it is pressed. You can expand quickly by holding the button down.

[⊖] button: Reduces images that have been enlarged.

[Esc] button: Cancels E-Zoom.



- The enlargement ratio appears on the screen. The selected area can be enlarged to between 1 to 4 times in 25 incremental steps.
- During enlarged projection, press the [⤴], [⤵], [⤶], or [⤷] button to scroll the image.

The projector has the following enhanced security functions.

- **Password Protect**  
You can limit who can use the projector.
- **Control Panel Lock**  
You can prevent people changing the settings on the projector without permission.  
☛ "Restricting Operation (Control Panel Lock)" [p.50](#)
- **Anti-Theft Lock**  
The projector is equipped with the following anti-theft security device.  
☛ "Anti-Theft Lock" [p.52](#)

---

## Managing Users (Password Protect)

When Password Protect is activated, people who do not know the password cannot use the projector to project images even if the projector power is on. Furthermore, the user's logo that is displayed when you turn on the projector cannot be changed. This acts as an anti-theft function as the projector cannot be used even if it is stolen. At the time of purchase, Password Protect is not activated.

### Kinds of Password Protect

The following three kinds of Password Protect settings can be made according to how the projector is being used.

- **Power On Protect**  
When **Power On Protect** is **On**, you need to enter a preset password after the projector is plugged in and turned on (this also applies to Direct Power On). If the correct password is not entered, projection does not start.

- **User's Logo Protect**

Even if someone tries to change the User's Logo set by the owner of the projector, it cannot be changed. When **User's Logo Protect** is set to **On**, the following setting changes for the User's Logo are prohibited.

- Capturing a User's Logo
- Setting **Display Background**, **Startup Screen**, or **A/V Mute** from **Display**  
☛ **Extended - Display** [p.61](#)

### Setting Password Protect

Use the following procedure to set Password Protect.



When password protect is set, use one of the following methods to turn on the projector.

- Set **Stack Mode** to **Off**, and then turn on the commander or the receiver.  
☛ "Clearing the Stacked Configuration and Using One Projector" [p.91](#)
- When **Stack Mode** is set to **On**, and then turn on one of the projectors (the commander or the receiver).  
For the commander: Hold down the [1] button on the remote control and then press the [⏻] button.  
For the receiver: Hold down the [2] button on the remote control and then press the [⏻] button.  
☛ "Turning On One Projector in a Stacked Configuration" [p.91](#)

While projecting in a stacked configuration, the password set for the commander is enabled.



- 1 During projection, hold down the [Freeze] button for about five seconds.

The Password Protect setting menu is displayed.

### Remote control

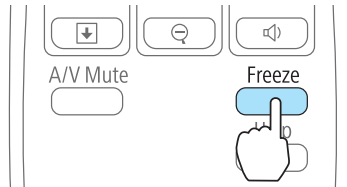

- If Password Protect is already activated, you must enter the password. If the password is entered correctly, the Password Protect setting menu is displayed.
  - ☞ "Entering the Password" p.49
- When the password is set, stick the supplied password protect sticker in a visible position on the projector as a further theft deterrent.

- 2 Select the type of Password Protect you want to set, and then press the [↵] button.

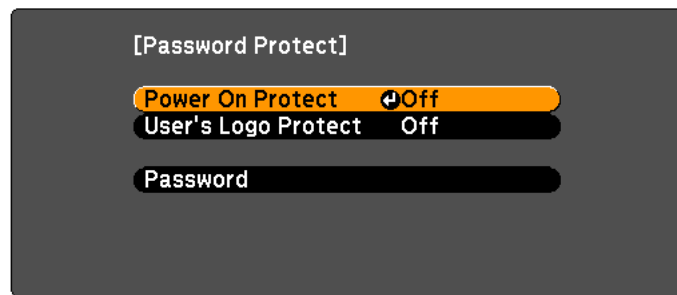

[↵]:Select [↵]:Enter [Menu]:Exit

- 3 Select **On**, and then press the [↵] button.

Press the [Esc] button, the screen displayed in step 2 is displayed again.

- 4 Set the password.

- (1) Select **Password**, and then press the [↵] button.
- (2) When the message "Change the password?" is displayed, select **Yes** and then press the [↵] button. The default password is set to "0000". Change this to your own desired Password. If you select **No**, the screen displayed in step 2 is displayed again.
- (3) While holding down the [Num] button, enter a four digit number using the numeric buttons. The number entered is displayed as "\* \* \* \*". When you enter the fourth digit, the confirmation screen is displayed.

### Remote control

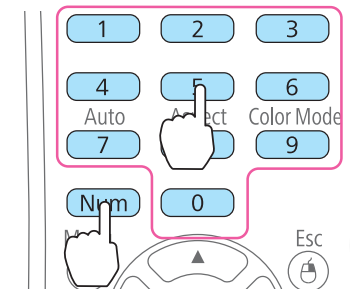

- (4) Re-enter the password. "The message Password accepted." is displayed. If you enter the password incorrectly, a message is displayed prompting you to re-enter the password.

## Entering the Password

When the password entry screen is displayed, enter the password using the remote control.

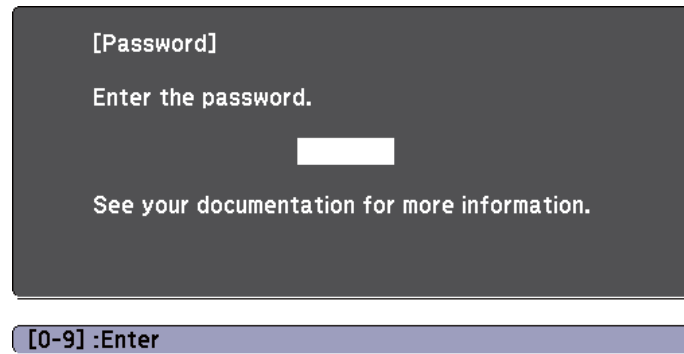

While projecting in a stacked configuration, the password set for the commander is enabled. Enter the password set for the commander.

While holding down the [Num] button, enter the password by pressing the numeric buttons.



When you enter the correct password, Password Protect is temporarily released.

### Attention

- If an incorrect password is entered three times in succession, the message "The projector's operation will be locked." is displayed for approximately five minutes, and then the projector switches to standby mode. If this happens, disconnect the power plug from the electrical outlet and then reinsert it and turn the projector's power back on. The projector displays the password entry screen again so that you can enter the correct password.
- If you have forgotten the password, make a note of the "Request Code: xxxxx" number that appears on the screen and contact the nearest address provided in the Epson Projector Contact List.  
 [Epson Projector Contact List](#)
- If you continue to repeat the above operation and enter the wrong password thirty times in succession, the following message is displayed and the projector does not accept any more password entries. "The projector's operation will be locked. Contact Epson as described in your documentation."  
 [Epson Projector Contact List](#)

## Restricting Operation (Control Panel Lock)

Perform one of the following to lock the operation buttons on the control panel.

- **Full Lock**  
All of the buttons on the control panel are locked. You cannot perform any operations from the control panel, including turning the power on or off.
- **Partial Lock**  
All of the buttons on the control panel, except for the [⏻] button, are locked.

This is useful at events or shows when you want to deactivate all buttons during projection or at schools when you want to limit button operation. The projector can still be operated using the remote control.

- 1 Press the [Menu] button while projecting.  
 "Using the Configuration Menu" [p.56](#)

### Using the remote control

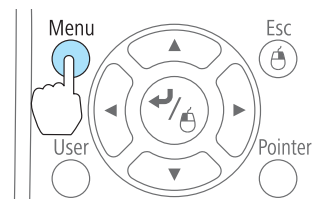

### Using the control panel

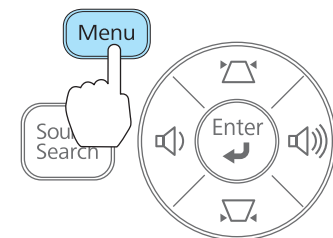

- 2 Select **Control Panel Lock** from **Settings**.

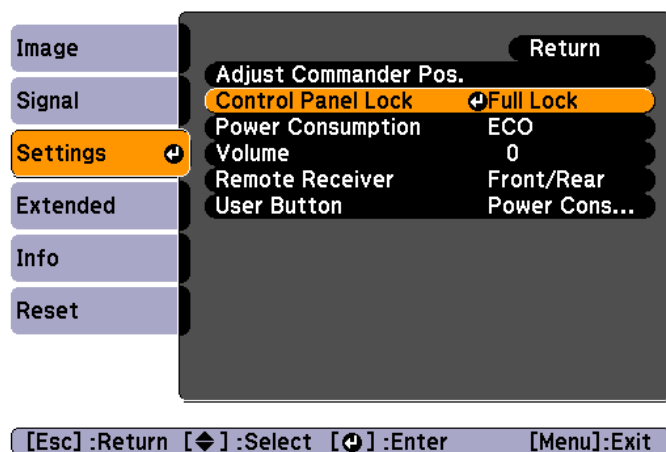

**3** Select either **Full Lock** or **Partial Lock** according to your purpose.

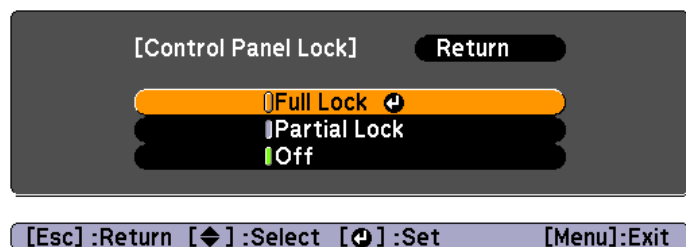

**4** Select **Yes** when the confirmation message is displayed.  
The control panel buttons are locked according to the setting you chose.



You can release the control panel lock by one of the following two methods.

- Select **Off** from **Control Panel Lock**.  
 **Settings - Control Panel Lock p.60**
- Press and hold down the [↵] button on the control panel for about seven seconds, a message is displayed and the lock is released.

## Anti-Theft Lock

The projector is equipped with the following types of anti-theft security devices.

- Security slot

The security slot is compatible with the Microsaver Security System manufactured by Kensington.

See the following for more details on the Microsaver Security System.

☞ <http://www.kensington.com/>

- Security cable installation point

A commercially available theft-prevention wire lock can be passed through the installation point to secure the projector to a desk or pillar.

### Installing the wire lock

Pass an anti-theft wire locks through the projectors and the stacker mounts.

See the documentation supplied with the wire lock for locking instructions.

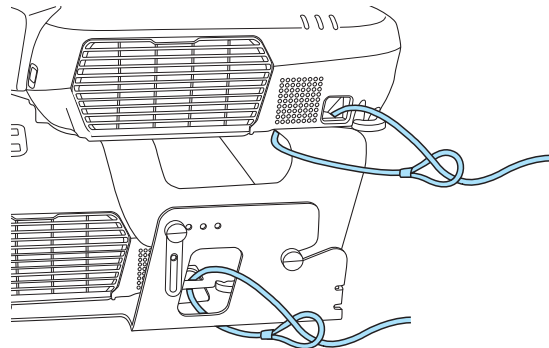

## ESC/VP21 Commands

You can control the projector from an external device using ESC/VP21.

### Before getting started

Connect the computer's serial port (D-Sub 9 pin) and the commander's RS-232C port with a PC serial cable.

- Connector shape: D-Sub 9-pin (male)
- Projector input port name: RS-232C

<At the projector>



<At the computer>

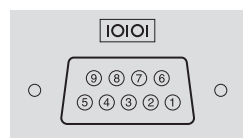

<At the projector>

(PC serial cable)

<At the computer>

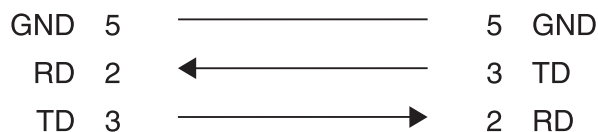

Signal Name	Function
GND	Signal wire ground
TD	Transmit data
RD	Receive data

## Command list

When the power ON command is transmitted to the projector, the power turns on and it enters warm-up mode. When the projector's power has turned on, a colon ":" (3Ah) is returned.

When a command is input, the projector executes the command and returns a ":", and then accepts the next command.

If the command being processed terminates abnormally, an error message is output and a ":" is returned.

The main contents are listed below.

Add a Carriage Return (CR) code (0Dh) to the end of each command and transmit.

Item		Command	
Power ON/OFF	On	PWR ON	
	Off	PWR OFF	
Signal selection	Computer1	Auto	SOURCE 1F
		RGB	SOURCE 11
		Component	SOURCE 14
	Computer2	Auto	SOURCE 2F
		RGB	SOURCE 21
		Component	SOURCE 24
	HDMI		SOURCE 30
	Video		SOURCE 41
	S-Video		SOURCE 42
A/V Mute On/Off	On	MUTE ON	
	Off	MUTE OFF	

For more details, contact your local dealer or the nearest address provided in the Epson Projector Contact List.



☛ [Epson Projector Contact List](#)

## Communications protocol

- Default baud rate setting: 9600 bps
- Data length: 8 bit
- Parity: None
- Stop-bit: 1 bit
- Flow control: None



# Configuration Menu

This chapter explains how to use the Configuration menu and its functions.

This section explains how to use the Configuration menu.

Although steps are explained using the remote control as an example, you can perform the same operations from the control panel. Check the guide under the menu for the available buttons and their operations.

## 1 Display the Configuration menu screen.

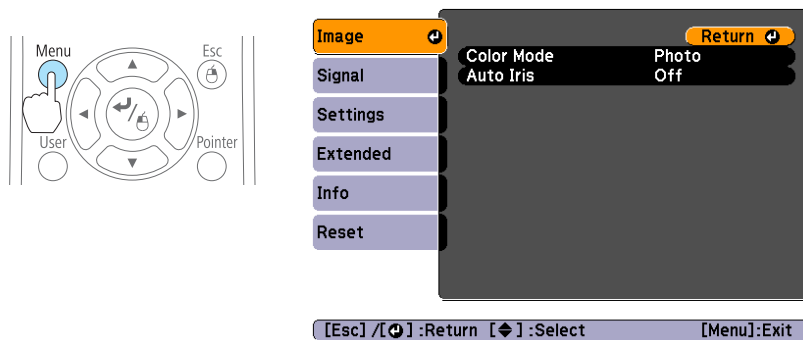

## 2 Select a top menu item.

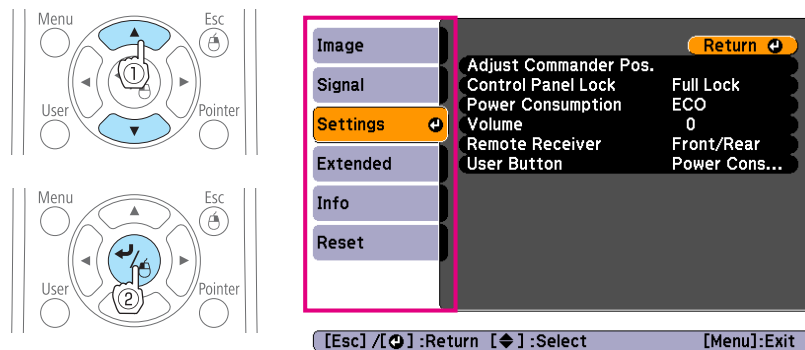

## 3 Select a submenu item.

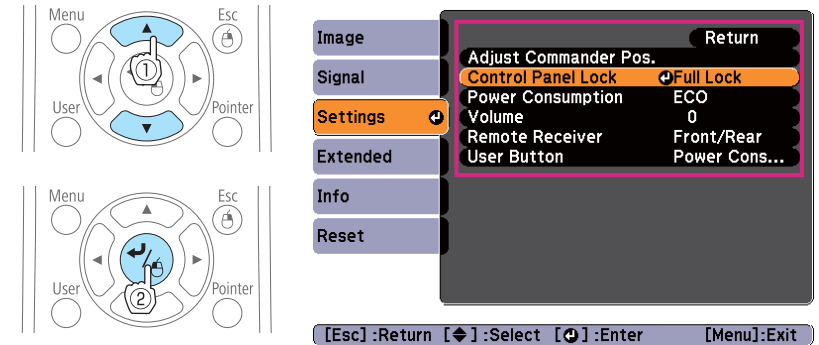

## 4 Change settings.

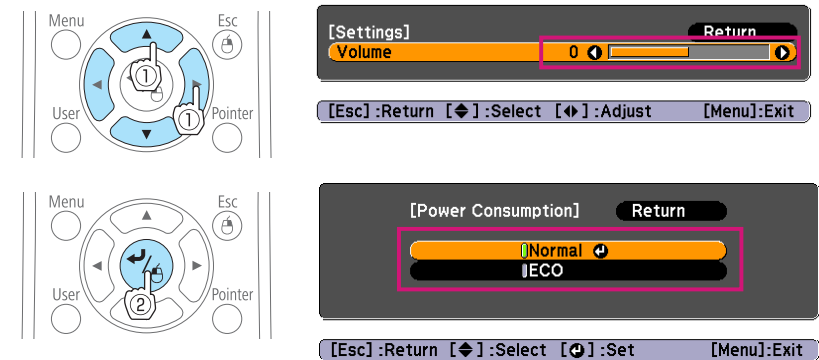

## 5 Press the [Menu] button to finish making settings.



## Configuration Menu Table

Apply the set items or values to the commander and the receiver.

Settable items vary depending on the model being used and the image signal and source being projected.

Top Menu Name	Submenu Name	Items or Setting Values
Image menu ☛ p.58	Color Mode	Dynamic, Presentation, Theatre, Photo, Sports, sRGB, Blackboard, Whiteboard, 3D Presentation, and 3D Theatre
	Auto Iris	On and Off
Signal menu ☛ p.58	Auto Setup	On and Off
	Resolution	Auto, Wide, and Normal
	3D Setup	3D Display, 3D Format, Inverse 3D Image, and 3D Viewing Notice
	Progressive	Off, Video, and Film/Auto
	Noise Reduction	Off, NR1, and NR2
	HDMI Video Range	Auto, Normal, and Expanded
	Input Signal	Auto, RGB, and Component
	Video Signal	Auto, NTSC, NTSC4.43, PAL, M-PAL, N-PAL, PAL60, and SECAM
	Aspect	Normal, Auto, 16:9, Full, Zoom, and Native
Settings menu ☛ p.60	Adjust Commander Pos.	Pattern Color (Commander), Pattern Color (Receiver), and Start Adjustments
	Control Panel Lock	Full Lock, Partial Lock, and Off
	Power Consumption	Normal and ECO

Top Menu Name	Submenu Name	Items or Setting Values
	Volume	0 to 10
	Remote Receiver	Front/Rear, Front, Rear, and Off
	User Button	Power Consumption, Info, Progressive, and Resolution
Extended menu ☛ p.61	Display	Messages, Display Background, Startup Screen, and A/V Mute
	Projection	Front, Front/Ceiling, Rear, and Rear/Ceiling
	Operation	Direct Power On, Sleep Mode, Sleep Mode Timer, Lens Cover Timer, High Altitude Mode, Monitor Out Port, and Stack Mode
	Language	15 or 35 languages* <sup>1</sup>
Info menu ☛ p.62	Lamp Hours	-
	Source	-
	Input Signal	-
	Resolution	-
	Video Signal	-
	Refresh Rate	-
	3D Format	-
	Sync Info	-
	Status	-
	Serial Number	-
Reset menu ☛ p.63	Reset Lamp Hours	Reset Lamp Hours (Commander) and Reset Lamp Hours (Receiver)

\* The number of supported languages differs depending on the region where the projectors are used.

## Image Menu

Settable items vary depending on the image signal and source currently being projected. Setting details are saved for each image signal.

☛ "Automatically Detect Input Signals and Change the Projected Image (Source Search)" [p.34](#)

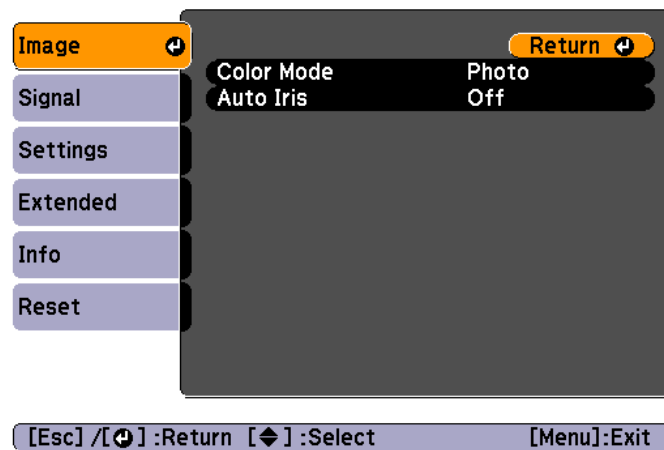

Submenu	Function
<b>Color Mode</b>	You can select the quality of the image to suit your surroundings. ☛ "Selecting the Projection Quality (Selecting Color Mode)" <a href="#">p.37</a>
<b>Auto Iris</b>	(This item can be set only if <b>Color Mode</b> is set to <b>Dynamic</b> , <b>Theatre</b> , or <b>3D Theatre</b> .) Set to <b>On</b> to adjust the iris to obtain the optimum light for images being projected. The setting is stored for each Color Mode. ☛ "Setting Auto Iris" <a href="#">p.38</a>

## Signal Menu

Settable items vary depending on the image signal and source currently being projected. Setting details are saved for each image signal.

☛ "Automatically Detect Input Signals and Change the Projected Image (Source Search)" [p.34](#)

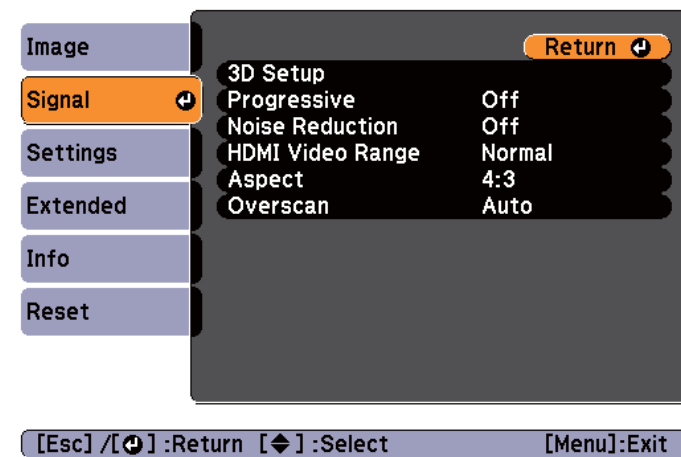



Submenu	Function
<b>Auto Setup</b>	(Only available when an analog RGB computer signal is being input.) Set to <b>On</b> to automatically adjust Tracking, Sync., and Position to the optimum state when the input signal changes.
<b>Resolution</b>	(Only available when an analog RGB computer signal is being input.) Set to <b>Auto</b> to automatically identify the resolution of the input signal. If images are not projected correctly when set to <b>Auto</b> , for example if some of the image is missing, adjust to <b>Wide</b> for wide screens, or set to <b>Normal</b> for 4:3 or 5:4 screens depending on the connected computer.

Submenu	Function
<b>3D Setup</b>	<p>Set when viewing 3D images.</p> <p><b>3D Display:</b> Set to <b>On</b> when viewing 3D content. If this is set to <b>Off</b>, 2D images are projected even when a 3D Input Signal is being input.</p> <p><b>3D Format:</b> Select the format for the 3D input signal. When set to <b>Auto</b>, the format is chosen automatically according to the input signal. Normally this should be set to <b>Auto</b>.</p> <p><b>Inverse 3D Image:</b> Inverses the images projected for the left eye and the right eye. Use this if you cannot view the 3D image correctly.</p> <p><b>3D Viewing Notice:</b> Set to <b>On</b> to display warnings regarding viewing 3D images. Displays warnings when viewing 3D images.</p>
<b>Progressive</b>	<p>(When a component video or RGB video is being input, this setting can only be adjusted if the signal being input is an interlaced signal (480i/576i/1080i). This cannot be set when a digital RGB signal is being input.)</p> <p><u>Interlace</u> (i) signal is converted to <u>Progressive</u> (p). (IP conversion)</p> <p><b>Off:</b> Ideal for images with a large amount of movement.</p> <p><b>Video:</b> Ideal for general video images.</p> <p><b>Film/Auto:</b> This is ideal for movie films, computer graphics, and animation.</p>
<b>Noise Reduction</b>	<p>(This cannot be set when a digital RGB signal is input or when projecting an interlaced signal while <b>Progressive</b> is set to <b>Off</b>.)</p> <p>Smooths out rough images. There are two modes. Select your favorite setting. It is recommended that this is set to <b>Off</b> when viewing image sources in which noise is very low, such as for DVDs.</p>
<b>HDMI Video Range</b>	<p>When the projector's HDMI port is connected to a DVD player, set the projector's video range according to the DVD player's video range setting.</p>

Submenu	Function
<b>Input Signal</b>	<p>You can select input signal from Computer port.</p> <p>If set to <b>Auto</b>, the input signal is set automatically according to the connected equipment.</p> <p>If colors do not appear correctly when set to <b>Auto</b>, select the appropriate signal according to the connected equipment.</p>
<b>Video Signal</b>	<p>You can select the input signal from the Video port. If set to <b>Auto</b>, video signals are recognized automatically. If interference appears in the image or a problem occurs such as no image is being projected when set to <b>Auto</b>, select the appropriate signal according to the connected equipment.</p>
<b>Aspect</b>	<p>You can set the <u>aspect ratio</u> for projected images.</p> <p>☛ "Changing the Aspect Ratio of the Projected Image" p.39</p>
<b>Overscan</b>	<p>(This setting can only be adjusted when a component video or RGB video signal is being input.)</p> <p>Changes the output image ratio (the range of the projected image). You can set the cropping range to <b>Off</b>, <b>4%</b>, or <b>8%</b>. When the source is HDMI, <b>Auto</b> is available. When <b>Auto</b> is selected, it automatically changes to <b>Off</b> or <b>8%</b> according to the input signal.</p>

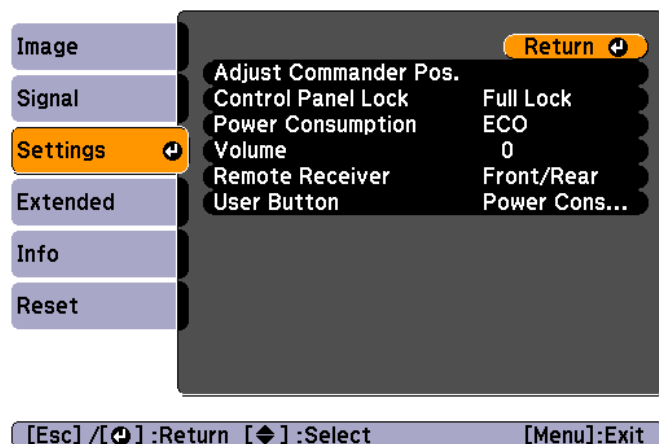
## Settings Menu



Submenu	Function
<b>Adjust Commander Pos.</b>	This is used when manually superimposing two images. <b>Pattern Color (Commander):</b> Select the color for the pattern used to denote the commander's projected image. <b>Pattern Color (Receiver):</b> Select the color for the pattern used to denote the receiver's projected image. <b>Start Adjustments:</b> Starts the adjustments. A screen that allows you to select the area you want to adjust is displayed.
<b>Control Panel Lock</b>	You can use this to restrict operation of the projector's control panel.  "Restricting Operation (Control Panel Lock)" <a href="#">p.50</a>

Submenu	Function
<b>Power Consumption</b>	You can set the lamp brightness to one of two settings. Select <b>ECO</b> if the images being projected are too bright, such as when projecting images in a dark room or onto a small screen. When <b>ECO</b> is selected, the power consumption and the lamp's operating life are changed as follows, and fan rotation noise during projection is reduced. Electrical consumption: about 17% decrease, lamp life: about 1.25 times longer When using at high altitude or in locations subject to high temperatures, you may not be able to change settings.
<b>Volume</b>	You can adjust the volume. Setting values are saved for each source.
<b>Remote Receiver</b>	You can limit the reception of the operation signal from the remote control. When set to <b>Off</b> , you cannot perform any operations from the remote control. If you want to make operations from the remote control, hold down the [Menu] button on the remote control for at least 15 seconds to reset the setting to its default value.
<b>User Button</b>	You can select and assign an item from the Configuration menu with the remote control's [User] button. Pressing the [User] button directly displays the assigned menu item selection/adjustment screen, allowing you to make one-touch changes to settings/adjustments. You can assign one of the following items to the [User] button. <b>Power Consumption, Info, Progressive, and Resolution</b>

## Extended Menu

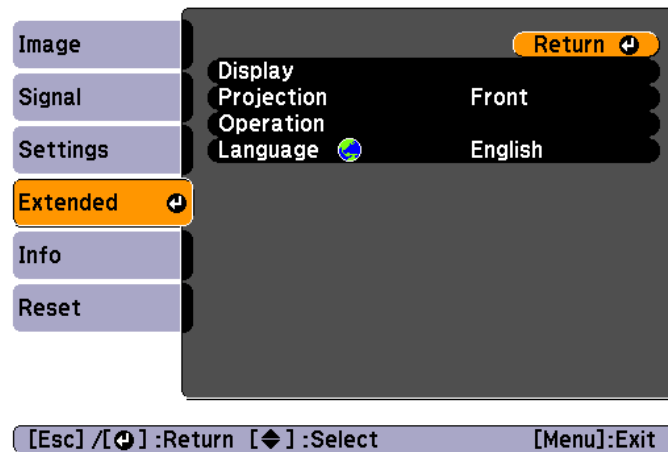

Submenu	Function
<b>Display</b>	<p>You can make settings related to the projector's display.</p> <p><b>Messages:</b> When set to <b>Off</b>, the following items will not be displayed.</p> <p>Item names when the Source, Color Mode, or Aspect Ratio is changed, messages when no signal is being input, and warnings such as High Temp Warning.</p> <p><b>Display Background</b>*1: You can set the screen background to <b>Black</b>, <b>Blue</b>, or <b>Logo</b> when no image signal is available.</p> <p><b>Startup Screen</b>*1: Set to <b>On</b> to display the <b>User's Logo</b> when projection starts.</p> <p><b>A/V Mute</b>*1: You can set the screen displayed when the remote control's [A/V Mute] button is pressed to <b>Black</b>, <b>Blue</b>, or <b>Logo</b>.</p>

Submenu	Function
<b>Projection</b>	<p>Select from one of the following projection methods depending on how the projector is installed.</p> <p><b>Front</b>, <b>Front/Ceiling</b>, <b>Rear</b>, and <b>Rear/Ceiling</b></p> <p>You can change the setting as follows by pressing down the [A/V Mute] button on the remote control for about five seconds.</p> <p><b>Front ↔ Front/Ceiling</b></p> <p><b>Rear ↔ Rear/Ceiling</b></p> <p> "Installation Methods" <a href="#">p.20</a></p>
<b>Operation</b>	<p><b>Direct Power On:</b> Set to <b>On</b> to turn on the projector simply by plugging it in.</p> <p>When the power cord is plugged in, note that the projector turns on automatically in cases such as a power outage being restored.</p> <p><b>Sleep Mode:</b> When set to <b>On</b>, this automatically stops projection when no image signal is being input to the commander and no operations are carried out.</p> <p><b>Sleep Mode Timer:</b> When <b>Sleep Mode</b> is set to <b>On</b>, you can set the time before the projector automatically turns off within a range of 1 to 30 minutes.</p> <p><b>Lens Cover Timer:</b> When set to <b>On</b>, this turns off the power automatically 30 minutes after the A/V mute slide is closed.</p> <p>The default value is <b>On</b>.</p> <p><b>High Altitude Mode:</b> Set to <b>On</b> when using the projector above an altitude of 1500 m.</p> <p><b>Monitor Out Port:</b> Changes the input and output for the Monitor Out/Computer2 port. Select <b>Monitor Out</b> when you want to output images to an external monitor, and select <b>Computer2</b> to input a computer image signal or a component video signal for video equipment.</p> <p><b>Stack Mode:</b> Set to <b>Off</b> if you are not using a stacked projector configuration. If you are using a stacked configuration, select <b>Commander</b> for the commander and <b>Receiver</b> for the receiver.</p>

Submenu	Function
<b>Language</b>	You can set the language for messages and menus.

\*1 When **User's Logo Protect** is set to **On** in **Password Protect**, settings related to user's logo cannot be changed. You can make changes after setting **User's Logo Protect** to **Off**.

☛ "Managing Users (Password Protect)" p.48

## Info Menu (Display Only)

You can check the status of the commander and the receiver. Items that can be displayed vary depending on the source currently being projected. Depending on the model used, some input sources are not supported.

☛ "Automatically Detect Input Signals and Change the Projected Image (Source Search)" p.34

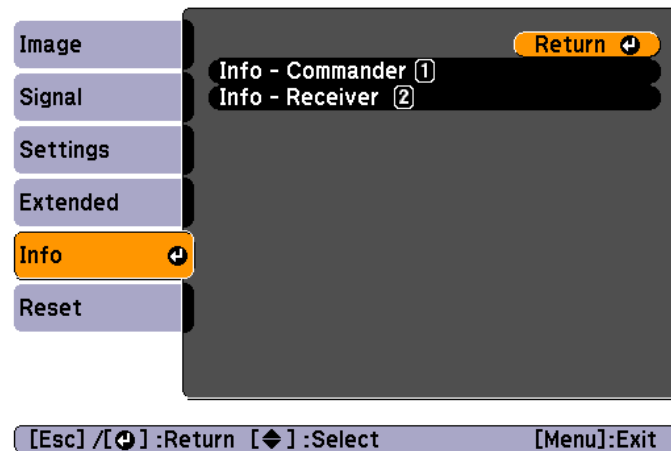

Submenu	Function
<b>Lamp Hours</b>	You can display the cumulative lamp operating time*. When the lamp replacement time is reached, the characters are displayed in yellow.

Submenu	Function
<b>Source</b>	You can display the source name for the connected equipment currently being projected.
<b>Input Signal</b>	You can display the content of <b>Input Signal</b> set in the <b>Signal</b> menu according to the source.
<b>Resolution</b>	You can display the resolution.
<b>Video Signal</b>	You can display the settings for <b>Video Signal</b> in the <b>Signal</b> menu.
<b>Refresh Rate</b>	You can display the <u>refresh rate</u> ▶.
<b>3D Format</b>	Displays the 3D format of the signal input during 3D projection (Frame Packing, Side by Side, or Top and Bottom).
<b>Sync Info</b>	You can display the image signal information. This information may be needed if service is required.
<b>Status</b>	This is information about errors that have occurred on the projector. This information may be needed if service is required.
<b>Serial Number</b>	Displays the projector's serial number.

\* The cumulative use time is displayed as "0H" for the first 10 hours. 10 hours and above is displayed as "10H", "11H", and so on.

## Reset Menu

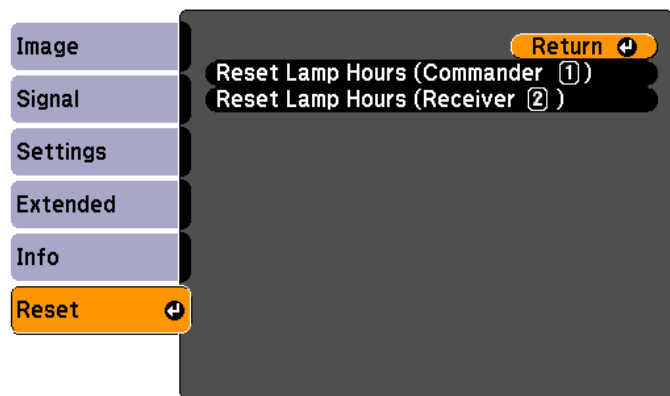

[Esc]/[Return] :Return [Enter] :Select [Menu]:Exit

Submenu	Function
<b>Reset Lamp Hours (Commander)</b>	Clears the cumulative lamp hours use time for the commander. Reset when you replace the lamp.
<b>Reset Lamp Hours (Receiver)</b>	Clears the cumulative lamp hours use time for the receiver. Reset when you replace the lamp.



# Troubleshooting

This chapter explains how to identify problems and what to do if a problem is found.



If a problem occurs with the projector, the Help screen is displayed to assist you by pressing the Help button. You can solve problems by answering the questions.

- 1** Press the [Help] button.  
The Help screen is displayed.

### Using the remote control

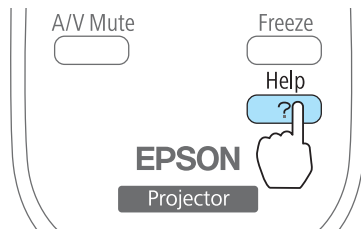

### Using the control panel

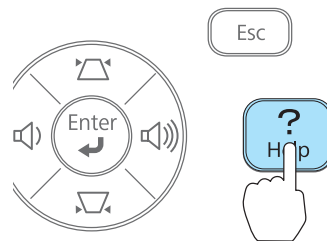

- 2** Select a menu item.

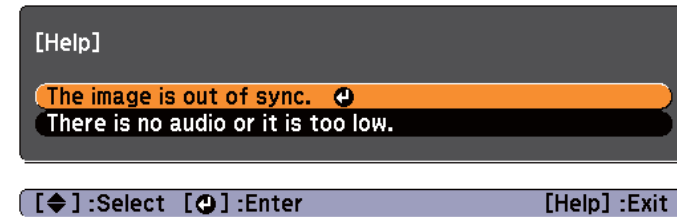

### Using the remote control

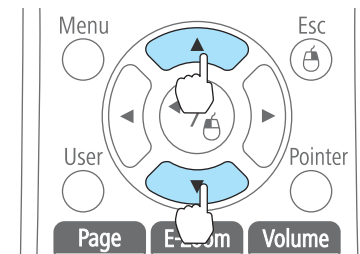

### Using the control panel

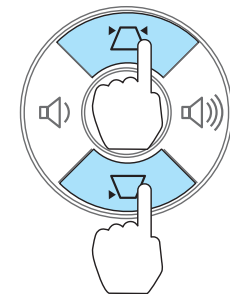

- 3** Confirm the selection.

### Using the remote control

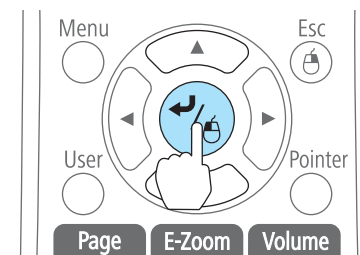

### Using the control panel

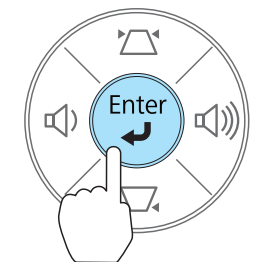

Questions and solutions are displayed as shown on the screen below.  
Press the [Help] button to exit the Help.

## The image is out of sync.

- Adjust the Commander's projection position.
- **Adjust Commander Pos.** 
- Press the [Screen Fit] button.

[Esc] :Return  :Enter [Help] :Exit



See the following if the Help function does not provide a solution to the problem.

 "Problem Solving" [p.67](#)

If you are having a problem with the projector, first check the projector's indicators and refer to "Reading the Indicators" below. See the following if the indicators do not show clearly what the problem might be.

☛ "When the Indicators Provide No Help" [p.71](#)

## Reading the Indicators



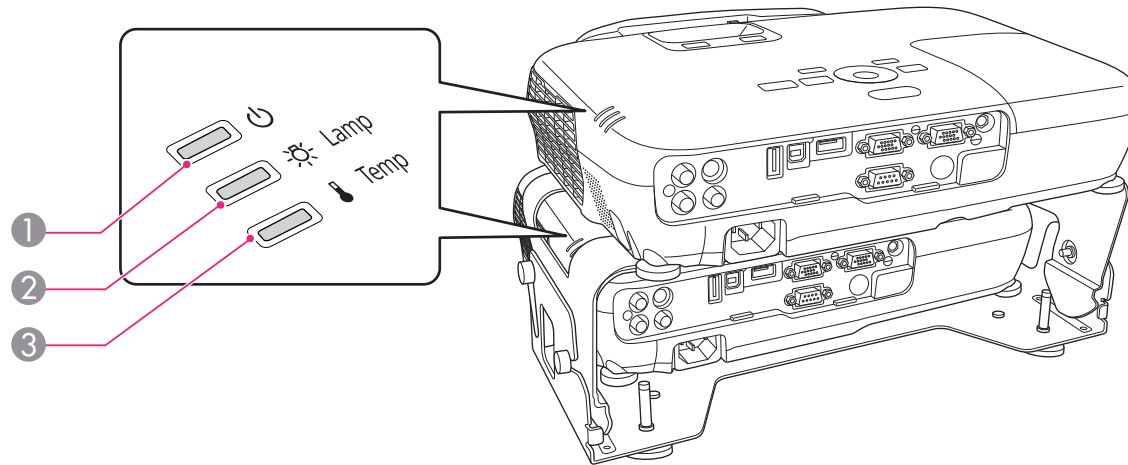

The projector has the following indicators that indicate its current operating status.

You can check the status of each projector by using the indicators on the commander and the receiver.



① Power indicator

Indicates the operating status.





-  Standby condition  
 When the [⏻] button is pressed in this condition, projection starts.
-  Cool-down in progress  
 All buttons are disabled while the indicator is flashing.
-  Warming up  
 Warm-up time is about 30 seconds. After warm-up is complete, the indicator stops flashing. The [⏻] button is disabled during warm-up.
-  Projecting















- ② Lamp indicator                      Indicates the projection lamp status.
- ③ Temp indicator                      Indicates the internal temperature status.











Refer to the following table to see what the indicators mean and how to remedy problems that they indicate.

If all indicators are off, check that the power cord is connected correctly and that the power is being supplied normally.

Sometimes, when the power cord is unplugged, the [⏻] indicator remains lit for a short period, but this is not a fault.

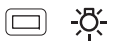
 : Lit    : Flashing    : Off    : Varies according to the projector status

Status	Cause	Remedy or Status
  	Internal Error	Stop using the projector, remove the power plug from the electrical outlet, and contact your local dealer or the nearest address provided in the Epson Projector Contact List.  <a href="#">Epson Projector Contact List</a>
  	Fan Error Sensor Error	Stop using the projector, remove the power plug from the electrical outlet, and contact your local dealer or the nearest address provided in the Epson Projector Contact List.  <a href="#">Epson Projector Contact List</a>
  	High Temp Error (Overheating)	The lamp turns off automatically and projection stops. Wait for about five minutes. After about five minutes the projector switches to standby mode, so check the following two points. <ul style="list-style-type: none"> <li>• Check that the air filter and air exhaust vent are clear, and that the projector is not positioned against a wall.</li> <li>• If the air filter is clogged, clean or replace it.                             <ul style="list-style-type: none"> <li> <a href="#">"Cleaning the Air Filter" p.83</a></li> <li> <a href="#">"Replacing the Air Filter" p.88</a></li> </ul> </li> </ul> If the error continues after checking the points above, stop using the projector, remove the power plug from the electrical outlet, and contact your local dealer or the nearest address provided in the Epson Projector Contact List.  <a href="#">Epson Projector Contact List</a>
		When using at an altitude of 1500 m or more, set <b>High Altitude Mode</b> to <b>On</b> .  <a href="#">"Extended Menu" p.61</a>

Status	Cause	Remedy or Status
  	Lamp Error Lamp Failure	<p>Check the following two points.</p> <ul style="list-style-type: none"> <li>• Take out the lamp and check if it is cracked.                             <ul style="list-style-type: none"> <li>☛ "Replacing the Lamp" <a href="#">p.84</a></li> </ul> </li> <li>• Clean the air filter.                             <ul style="list-style-type: none"> <li>☛ "Cleaning the Air Filter" <a href="#">p.83</a></li> </ul> </li> </ul> <p><b>If the lamp is not cracked:</b> Reinstall the lamp and turn on the power.  <b>If the error continues:</b> Replace the lamp with a new one and then turn on the power.  <b>If the error continues:</b> Stop using the projector, remove the power plug from the electrical outlet, and contact your local dealer or the nearest address provided in the Epson Projector Contact List.                      ☛ <a href="#">Epson Projector Contact List</a></p> <p><b>If the lamp is cracked:</b> Contact your local dealer or the nearest address provided in the Epson Projector Contact List. (Images cannot be projected until the lamp is replaced.)                      ☛ <a href="#">Epson Projector Contact List</a></p> <p>When using at an altitude of 1500 m or more, set <b>High Altitude Mode</b> to <b>On</b>.                      ☛ "Extended Menu" <a href="#">p.61</a></p>
  	Auto Iris Error Power Err.	<p>Stop using the projector, remove the power plug from the electrical outlet, and contact your local dealer or the nearest address provided in the Epson Projector Contact List.                      ☛ <a href="#">Epson Projector Contact List</a></p>
  	High Temp Warning	<p>(This is not an abnormality. However, if the temperature rises too high again, projection stops automatically.)</p> <ul style="list-style-type: none"> <li>• Check that the air filter and air exhaust vent are clear, and that the projector is not positioned against a wall.</li> <li>• If the air filter is clogged, clean or replace it.                             <ul style="list-style-type: none"> <li>☛ "Cleaning the Air Filter" <a href="#">p.83</a></li> <li>☛ "Replacing the Air Filter" <a href="#">p.88</a></li> </ul> </li> </ul>
  	Replace Lamp	<p>Replace it with a new lamp.                      ☛ "Replacing the Lamp" <a href="#">p.84</a></p> <p>If you continue to use the lamp after the replacement period has passed, the possibility that the lamp may explode increases. Replace it with a new lamp as soon as possible.</p>













- See the following if the projector is not operating properly, even though the indicators are all showing normal.
  - ☛ "When the Indicators Provide No Help" [p.71](#)
- If the indicators are in a state not shown in this table, stop using the projector, remove the power plug from the electrical outlet, and contact your local dealer or the nearest address provided in the Epson Projector Contact List.
  - ☛ [Epson Projector Contact List](#)

## When the Indicators Provide No Help

If any of the following problems occur and the indicators do not offer a solution, refer to the pages given for each problem.



### Problems Relating to Images

<ul style="list-style-type: none"> <li>• <b>No images appear</b> Projection does not start, the projection area is completely black, or the projection area is completely blue.</li> </ul>	 <a href="#">p.72</a>
<ul style="list-style-type: none"> <li>• <b>Moving images are not displayed</b> Moving images being projected from a computer appear black and nothing is projected, or no moving images are played back on the computer.</li> </ul>	 <a href="#">p.73</a>
<ul style="list-style-type: none"> <li>• <b>Projection stops automatically</b></li> </ul>	 <a href="#">p.73</a>
<ul style="list-style-type: none"> <li>• <b>The message "Not supported" is displayed</b></li> </ul>	 <a href="#">p.73</a>
<ul style="list-style-type: none"> <li>• <b>The message "No Signal" is displayed</b></li> </ul>	 <a href="#">p.73</a>
<ul style="list-style-type: none"> <li>• <b>Cannot view 3D images</b></li> </ul>	 <a href="#">p.74</a>
<ul style="list-style-type: none"> <li>• <b>Images are fuzzy, out of focus, or distorted</b></li> </ul>	 <a href="#">p.75</a>
<ul style="list-style-type: none"> <li>• <b>Interference or distortion appear in images</b></li> </ul>	 <a href="#">p.75</a>
<ul style="list-style-type: none"> <li>• <b>The image is truncated (large) or small, the aspect ratio is not suitable, or the image has been reversed</b> Only part of the image is displayed, the height and width ratios of the image are not correct, or the image may appear reversed from top to bottom or left to right.</li> </ul>	 <a href="#">p.76</a>
<ul style="list-style-type: none"> <li>• <b>Image colors are not right</b> The whole image appears purplish or greenish, images are black &amp; white, or colors appear dull.</li> </ul>	 <a href="#">p.76</a>
<ul style="list-style-type: none"> <li>• <b>Images appear dark</b></li> </ul>	 <a href="#">p.77</a>

### Problems when projection starts

<ul style="list-style-type: none"> <li>• <b>The projector does not turn on</b></li> </ul>	 <a href="#">p.77</a>
<ul style="list-style-type: none"> <li>• <b>One of the projectors is not turned on</b></li> </ul>	 <a href="#">p.78</a>

### Other Problems

<ul style="list-style-type: none"> <li>• <b>No sound can be heard or the sound is faint</b></li> </ul>	 <a href="#">p.78</a>
<ul style="list-style-type: none"> <li>• <b>The remote control does not work</b></li> </ul>	 <a href="#">p.79</a>
<ul style="list-style-type: none"> <li>• <b>I want to change the language for messages and menus</b></li> </ul>	 <a href="#">p.80</a>

## Problems Relating to Images

### No images appear

Check	Remedy
Did you press the [⏻] button?	Press the [⏻] button to turn the power on.
Are the indicators switched off?	The power cord is not connected correctly or power is not being supplied. Connect the projector's power cord correctly. ☛ "From Installation to Projection" <a href="#">p.32</a> Check that your electrical outlet or power source is functioning correctly.
Is A/V Mute active?	Press the [A/V Mute] button on the remote control to cancel A/V Mute. ☛ "Hiding the Image and Sound Temporarily (A/V Mute)" <a href="#">p.45</a>
Is the A/V mute slide closed?	Open the A/V mute slide. ☛ "Front/Top" <a href="#">p.9</a>
Is the image to be projected completely black? (Only when projecting computer images)	Some input images, such as screen savers, may be completely black.
Is the image signal format setting correct? (Only when projecting images from a video source)	Change the setting according to the signal for the connected equipment. ☛ <b>Signal - Video Signal</b> <a href="#">p.58</a>
Is <b>Monitor Out Port</b> set to <b>Monitor Out</b> ?	When projecting images being input to the Monitor Out/Computer2 port, set the <b>Monitor Out Port</b> to <b>Computer2</b> from the Configuration menu. ☛ <b>Extended - Operation - Monitor Out Port</b> <a href="#">p.61</a>
Is a different device connected to the commander and the receiver?	No image is displayed if the signals input to the commander and the receiver are from different devices. Connect the device to the projectors correctly. ☛ "Connecting Equipment" <a href="#">p.21</a>



## Moving images are not displayed

Check	Remedy
Is the computer's image signal being output to the LCD and the monitor? (Only when projecting images from a laptop computer or a computer with a built-in LCD screen)	Change the image signal from the computer to external output only. Check your computer's documentation, or contact the computer's manufacturer.
Are the contents of the moving image you are trying to project copyright protected?	The projector may not be able to project copyright protected moving images that are being played back on a computer. For more details, see the user's guide supplied with the player.

## Projection stops automatically

Check	Remedy
Is <b>Sleep Mode</b> set to <b>On</b> ?	Press the [⏻] button to turn the power on. If you do not want to use Sleep Mode, change the setting to <b>Off</b> . ☛ <b>Extended - Operation - Sleep Mode</b> <a href="#">p.61</a>

## The message "Not supported" is displayed

Check	Remedy
Is the image signal format setting correct? (Only when projecting images from a video source)	Change the setting according to the signal for the connected equipment. ☛ <b>Signal - Video Signal</b> <a href="#">p.58</a>
Do the image signal resolution and the refresh rate correspond to the mode? (Only when projecting computer images)	Refer to the computer's documentation for how to change the image signal resolution and the refresh rate output from the computer. ☛ "Supported Monitor Displays" <a href="#">p.98</a>

## The message "No Signal" is displayed

Check	Remedy
Are the cables connected correctly?	Check that all the cables required for projection are securely connected. Check that no cables are disconnected and that there are no poor contacts in the cables. ☛ "From Installation to Projection" <a href="#">p.32</a>

Check	Remedy
Is the correct port selected?	Change the image by pressing the [Source Search] button on the commander's control panel or remote control. ☛ "Automatically Detect Input Signals and Change the Projected Image (Source Search)" <a href="#">p.34</a>
Is the power for the computer or video source turned on?	Turn the power on for the equipment.
Are the image signals being output to the projector? (Only when projecting images from a laptop computer or a computer with a built-in LCD screen)	If the image signals are only being output to the computer's LCD monitor or to the accessory monitor, you need to change the output to an external destination as well as the computer's own monitor. For some computer models, when the image signals are output externally, they no longer appear on the LCD monitor or accessory monitor. If the connection is made while the power of the projector or computer is already turned on, the Fn key (Function key) that changes the computer's image signal to external output may not work. Turn the power for the computer and the projector off and then back on again. ☛ "From Installation to Projection" <a href="#">p.32</a> ☛ Computer's documentation

## Cannot view 3D images

Check	Remedy
Is the Configuration menu set correctly?	<ul style="list-style-type: none"> <li>• Set <b>3D Display</b> to <b>On</b>.</li> <li>• Set <b>3D Format</b> to <b>Auto</b> or the same format as the 3D signal from the connected device.</li> </ul> ☛ <a href="#">Signal - 3D Setup p.58</a>
Is the input signal a 3D signal?	Check that the connected playback device and the content being played support 3D signals.
Do the HDMI cables and the HDMI splitter support 3D signals?	Use HDMI cables and an HDMI splitter that support 3D signals.
Is the polarizer attached correctly?	<ul style="list-style-type: none"> <li>• If the projector and the polarizer are not combined correctly, you cannot view 3D images. Attach so that the number on the base of the projector and the polarizer match. See the following manual for details. ☛ <a href="#">Startup Guide</a></li> <li>• Perform <b>Inverse 3D Image</b> from <b>3D Setup</b>. ☛ <a href="#">Signal - 3D Setup p.58</a></li> </ul>
Are you using a silver screen designed for passive 3D images?	These projectors can only project 3D images onto a silver screen. Prepare a silver screen designed for passive 3D images.
Are you wearing the 3D Glasses correctly?	To view 3D images with the projectors, you need passive polarized 3D glasses. Use the supplied or optional 3D Glasses (ELPGS02A/ELPGS02B). ☛ "Optional Accessories" <a href="#">p.94</a>

## Images are fuzzy, out of focus, or distorted

Check	Remedy
Are the images from the commander and the receiver superimposed correctly?	Press the [Screen Fit] button. The adjustment screen is displayed and the images are superimposed correctly after a few seconds. See the following manual when superimposing images for the first time after installation. ☛ <a href="#">Startup Guide</a>
Is <b>Auto Setup</b> set to <b>Off</b> ?	When set to <b>On</b> , <b>Tracking</b> , <b>Sync.</b> , and <b>Position</b> are automatically optimized. ☛ <a href="#">Signal - Auto Setup p.58</a>
Is the projector at the correct distance?	Is it projecting outside of the recommended projection distance range? Setup within the recommended range. ☛ <a href="#">"Screen Size and Projection Distance" p.96</a>
Has condensation formed on the lens?	If the projector is suddenly taken from a cold environment to a warm environment, or if sudden ambient temperature changes occur, condensation may form on the surface of the lens, and this may cause the images to appear fuzzy. Set the projector up in the room about one hour before it is used. If condensation forms on the lens, turn the projector off and wait for the condensation to disappear.

## Interference or distortion appear in images

Check	Remedy
Is the image signal format setting correct? (Only when projecting images from a video source)	Change the setting according to the signal for the connected equipment. ☛ <a href="#">Signal - Video Signal p.58</a>
Are the cables connected correctly?	Check that all the cables required for projection are securely connected. ☛ <a href="#">"Connecting Equipment" p.21</a>
Is an extension cable being used?	If an extension cable is used, electrical interference may affect the signals. Use the cables supplied with the projector to check if the cables you are using may be causing the problem.
Is the correct resolution selected? (Only when projecting computer images)	Set the computer so that the signals being output are compatible with the projector. ☛ <a href="#">"Supported Monitor Displays" p.98</a> ☛ Computer's documentation
Are the <b>Sync.</b> and <b>Tracking</b> settings adjusted correctly? (Only when projecting computer images)	Press the [Auto] button on the remote control or the [↩] button on the control panel to perform automatic adjustment.

## The image is truncated (large) or small, the aspect is not suitable, or the image has been reversed

Check	Remedy
Is a wide panel computer image being projected? (Only when projecting computer images)	Change the setting according to the signal for the connected equipment. ☛ <b>Signal - Resolution</b> p.58
Is the image still being enlarged by E-Zoom?	Press the [Esc] button on the remote control to cancel E-Zoom. ☛ "Enlarging Part of the Image (E-Zoom)" p.47
Is the image position adjusted correctly?	(Only when projecting analog RGB signals input from the Computer port) Press the [Auto] button on the remote control or the [↵] button on the control panel to adjust the position.
Is the computer set for dual display? (Only when projecting computer images)	If dual display is activated in the <b>Display Properties</b> of the computer's Control Panel, only about half of the image on the computer screen is projected. To display the entire image on the computer screen, turn off the dual display setting. ☛ Computer video driver documentation
Is the correct resolution selected? (Only when projecting computer images)	Set the computer so that the signals being output are compatible with the projector. ☛ "Supported Monitor Displays" p.98 ☛ Computer's documentation
Is the projection mode correct?	Depending on how the projector is installed, set the projection mode from one of the following: <b>Front, Front/Ceiling, Rear, or Rear/Ceiling.</b> ☛ <b>Extended - Projection</b> p.61 ☛ "Installation Methods" p.20

## Image colors are not right

Check	Remedy
Do the input signal settings match the signals from the connected device?	Change the following settings according to the signal for the connected equipment. <ul style="list-style-type: none"> <li>• When the image is from a device connected to the Computer port ☛ <b>Signal - Input Signal</b> p.58</li> <li>• When the image is from a device connected to the Video port ☛ <b>Signal - Video Signal</b> p.58</li> </ul>
Are the cables connected correctly?	Check that all the cables required for projection are securely connected. Check that no cables are disconnected and that there are no poor contacts in the cables. ☛ "Connecting Equipment" p.21

## Images appear dark

Check	Remedy
Is it time to replace the lamp?	When the lamp is nearly ready for replacement, the images become darker and the color quality becomes poorer. When this happens, replace the lamp with a new lamp. ☛ "Replacing the Lamp" p.84
Is the polarizer attached?	Brightness is reduced when the polarizer is attached. If the image is too dark when projecting 2D images, remove the polarizer. Slide the polarizer horizontally, unhook the catch, and then pull it forward. You need to reattach the polarizer to view 3D images.
Are you using the projector at a high altitude or in a location subject to high temperatures?	The screen may become dark when using at high altitude or in a location subject to high temperatures. Although you cannot make <b>Power Consumption</b> settings at this time, you can continue to use the projector.

## Problems when Projection Starts

### The projector does not turn on

Check	Remedy
Did you press the [⏻] button?	Press the [⏻] button to turn the power on.
Are the indicators switched off?	The power cord is not connected correctly or power is not being supplied. Disconnect and then reconnect the power cord. ☛ "From Installation to Projection" p.32 Check that your electrical outlet or power source is functioning correctly.
Do the indicators turn on and off when the power cord is touched?	There is probably a poor contact in the power cable, or the power cable may be defective. Reinsert the power cable. If this does not solve the problem, stop using the projector, disconnect the power cord from the electrical outlet, and contact your local dealer or the nearest address provided in the Epson Projector Contact List. ☛ <a href="#">Epson Projector Contact List</a>
Is the <b>Control Panel Lock</b> set to <b>Full Lock</b> ?	Press the [⏻] button on the remote control. If you do not want to use <b>Control Panel Lock</b> , change the setting to <b>Off</b> . ☛ <a href="#">Settings - Control Panel Lock p.60</a>
Is the correct setting for the remote receiver selected?	Check the <b>Remote Receiver</b> from the Configuration menu. ☛ <a href="#">Settings - Remote Receiver p.60</a>

## One of the projectors is not turned on, or the projectors have not been linked together

Check	Remedy
Are the commander and receiver connected correctly with a USB cable?	Connect the commander's USB(TypeA) port to the receiver's USB(TypeB) port with a USB cable. Also, check that the USB cable is not disconnected. ☛ <a href="#">Startup Guide</a> ☛ "From Installation to Projection" p.32
Is <b>Stack Mode</b> set to <b>Off</b> ?	Commander: Set <b>Stack Mode</b> to <b>Commander</b> . Receiver: Set <b>Stack Mode</b> to <b>Receiver</b> . ☛ <a href="#">Extended - Operation - Stack Mode p.61</a>
Has an error occurred in the commander?	If any errors occur in the commander, the receiver displays a warning message. In this situation, the only available operation is to turn off the receiver. Press the [↵] button on the remote control to turn off the receiver. Stop using the commander, and contact your local dealer or the nearest address provided in the Epson Projector Contact List. ☛ <a href="#">Epson Projector Contact List</a> If you want to turn on the receiver only, hold down the [2] button on the remote control and then press the [⏻] button.
Has an error occurred in the receiver?	If any errors occur in the receiver, the commander displays a warning message. In this situation, the commander can be operated as normal. Stop using the receiver, and contact your local dealer or the nearest address provided in the Epson Projector Contact List. ☛ <a href="#">Epson Projector Contact List</a> If you want to turn on the commander only, hold down the [1] button on the remote control and then press the [⏻] button.

## Other Problems

### No sound can be heard or the sound is faint

Check	Remedy
Check that the audio/video cable is securely attached to both the projector and audio source.	Disconnect the cable from the Audio port, and then reconnect the cable.

Check	Remedy
Is the projector volume set to the minimum?	Adjust the volume so that sound can be heard. 🖱️ <a href="#">Settings - Volume p.60</a> 🖱️ <a href="#">"Adjusting the Volume" p.37</a>
Is the volume for the computer or from the image source set to the minimum?	Adjust the volume so that sound can be heard.
Is A/V Mute active?	Press the [A/V Mute] button on the remote control to cancel A/V Mute. 🖱️ <a href="#">"Hiding the Image and Sound Temporarily (A/V Mute)" p.45</a>
Is the audio cable's specification "No resistance"?	When using a commercially available audio cable, make sure it is labeled "No resistance".
Is it connected with an HDMI cable?	If no audio is output when connecting via an HDMI cable, set the connected equipment to PCM output.

## The remote control does not work

Check	Remedy
Is the remote control light-emitting area pointing towards the remote receiver on the projector during operation?	Point the remote control towards the remote receiver. 🖱️ <a href="#">"Remote control operating range" p.18</a>
Is the remote control too far from the projector?	The operating range for the remote control is about 6 m. 🖱️ <a href="#">"Remote control operating range" p.18</a>
Is direct sunlight or strong light from fluorescent lamps shining onto the remote receiver?	Set the projector up in a location where strong light does not shine onto the remote receiver. Or set the remote receiver to <b>Off</b> from <b>Remote Receiver</b> in the Configuration menu. 🖱️ <a href="#">Settings - Remote Receiver p.60</a>
Is the correct setting for the <b>Remote Receiver</b> selected?	Check the <b>Remote Receiver</b> from the Configuration menu. 🖱️ <a href="#">Settings - Remote Receiver p.60</a>
Are the batteries dead or have the batteries been inserted correctly?	Make sure the batteries are inserted correctly or replace the batteries with new ones if necessary. 🖱️ <a href="#">"Replacing the remote control batteries" p.17</a>

## I want to change the language for messages and menus

Check	Remedy
Change the Language setting.	Adjust the Language setting from the Configuration menu. ☛ <a href="#">Extended - Language p.61</a>





# Maintenance

This chapter provides information on maintenance procedures to ensure the best level of performance from the projector for a long time to come.

You should clean the projector if it becomes dirty or if the quality of projected images starts to deteriorate.



## Caution

Turn off the projector's power before cleaning. Otherwise, it could cause an electric shock.

## Cleaning the Projector's Surface

Clean the projector's surface by wiping it gently with a soft cloth.

If the projector is particularly dirty, moisten the cloth with water containing a small amount of neutral detergent, and then firmly wring the cloth dry before using it to wipe the projector's surface.

## Attention

Do not use volatile substances such as wax, alcohol, or thinner to clean the projector's surface. The quality of the case may change or become discolored.

## Cleaning the Lens

Use a commercially available cloth for cleaning glasses to gently wipe the lens.



## Warning

Do not use sprays that contain flammable gas to remove dust and lint from the lens. The projector may catch fire due to the high internal temperature of the lamp.

## Attention

Do not rub the lens with harsh materials or subject the lens to shocks as it can easily become damaged.

## Cleaning the Polarizer

Clean the polarizer's surface by wiping it gently with a soft cloth.

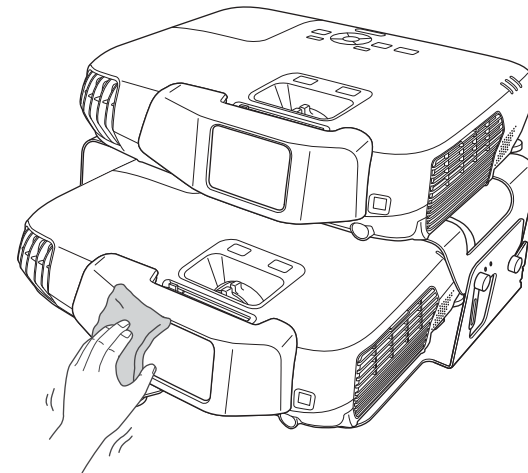

## Attention

Do not rub the polarizer with harsh materials or handle it too roughly as it can easily become damaged.

## Cleaning the 3D Glasses

Clean the lenses of the glasses by wiping them gently with a soft cloth.

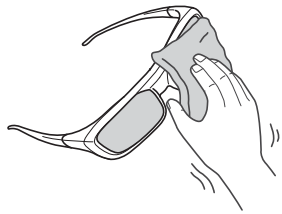

### Attention

- Do not rub the lenses of the glasses with harsh materials or handle them too roughly as they can easily become damaged.

## Cleaning the Air Filter

Clean the air filter and the air intake vent when the following message is displayed.

**The projector is overheating.  
Make sure nothing is blocking the air vent, and clean or replace the air filter.**



Regarding the numbers displayed next to icons; 1 indicates the commander and 2 indicates the receiver.

Clean or replace the air filter for the projector indicated by the arrow.

### Attention

- If dust collects on the air filter, it can cause the internal temperature of the projector to rise, and this can lead to problems with operation and shorten the optical engine's service life. Clean the air filter immediately when the message is displayed.
- Do not rinse the air filter in water. Do not use detergents or solvents.

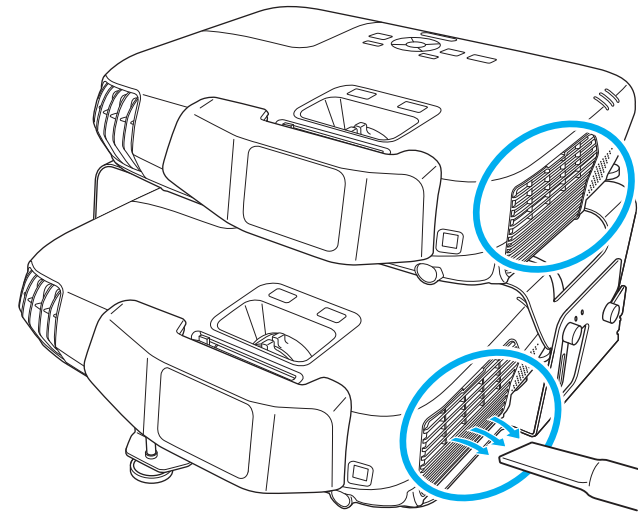

- If a message is frequently displayed, even after cleaning, it is time to replace the air filter. Replace it with a new air filter.
  - ☛ "Replacing the Air Filter" p.88
- It is recommended that you clean these parts at least once every three months. Clean them more often than this if using the projector in a particularly dusty environment.

This section explains how to replace the lamp and the air filter.

## Replacing the Lamp

### Lamp replacement period

It is time to replace the lamp when:

- The following message is displayed.

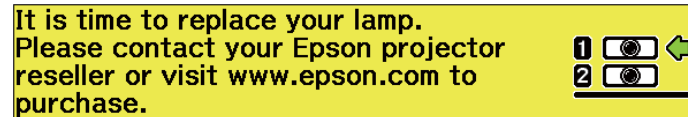

Regarding the numbers displayed next to icons; 1 indicates the commander and 2 indicates the receiver.

Replace the lamp for the projector indicated by the arrow.

The message is displayed for 30 seconds.

- The lamp indicator flashes orange.

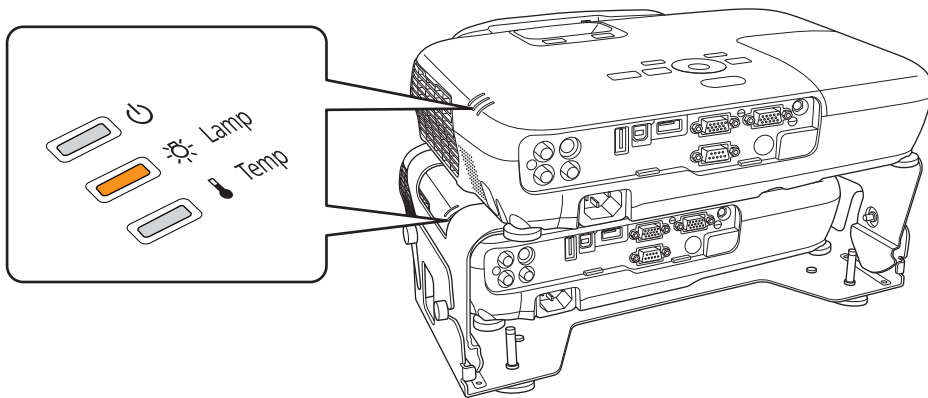

- The projected image gets darker or starts to deteriorate.

### Attention

- The lamp replacement message is set to appear after the following time periods in order to maintain the initial brightness and quality of the projected images.

When using **Power Consumption** continually at **Normal**: About 3900 hours

When using **Power Consumption** continually at **ECO**: About 4900 hours

☛ **Settings - Power Consumption p.60**

- If you continue to use the lamp after the replacement period has passed, the possibility that the lamp may explode increases. When the lamp replacement message appears, replace the lamp with a new one as soon as possible, even if it is still working.
- Do not repeatedly turn off the power and immediately back on. Turning the power on and off frequently may shorten the lamp's operating life.
- Depending on the characteristics of the lamp and the way it has been used, the lamp may become darker or stop working before the lamp warning message appears. You should always have a spare lamp unit ready in case it is needed.

### How to replace the lamp

The lamp can be replaced even when the projector is suspended from a ceiling.

## Warning

- When replacing the lamp because it has stopped illuminating, there is a possibility that the lamp may be broken. If replacing the lamp of a projector which has been installed on the ceiling, you should always assume that the lamp is cracked, and you should stand to the side of the lamp cover, not underneath it. Remove the lamp cover gently. Be careful when removing the lamp cover as shards of glass may fall out and could cause an injury. If any shards of glass get into your eyes or mouth, contact your local physician immediately.
- Never disassemble or remodel the lamp. If a modified or disassembled lamp is installed in the projector and used, it could cause a fire, electric shock, or an accident.

## Caution

- Wait until the lamp has cooled down sufficiently before removing the lamp cover. If the lamp is still hot, burns or other injuries may result. It takes about one hour after the power has been turned off for the lamp to be cool enough.
- When the projectors are in a stacked configuration, follow the steps in the User's Guide to replace the lamps. If the steps are not followed correctly, the product could fall, or your fingers could get caught, which could cause an injury to occur.

## Attention

- Make sure you install the lamp securely. If the lamp cover is removed, the power turns off automatically as a safety precaution. If the lamp or the lamp cover is not installed correctly, the power does not turn on.
- This product includes a lamp component that contains mercury (Hg). Please consult your local regulations regarding disposal or recycling. Do not dispose of it with normal waste.

## Replacing the lamp for the commander

- 1** After you turn off the projector's power and the confirmation buzzer beeps twice, disconnect the power cord.
- 2** Wait until the lamp has sufficiently cooled down, and then remove the lamp cover at the top of the projector.

Loosen the Lamp cover fixing screw with the screwdriver supplied with the new lamp unit or a cross-head screwdriver. Then slide the lamp cover straight forward and lift it to remove.

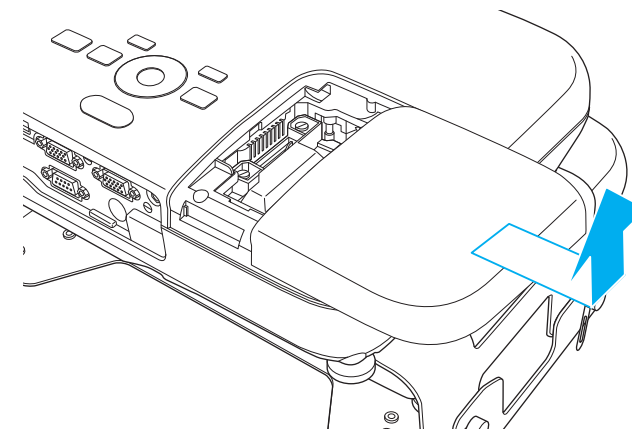
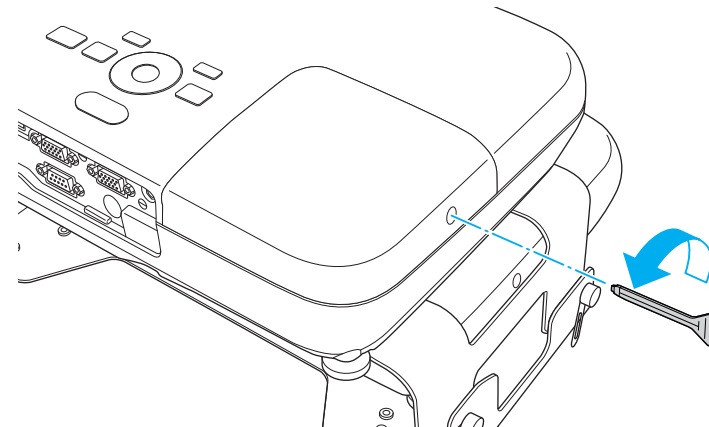

- 3** Loosen the two lamp fixing screws.

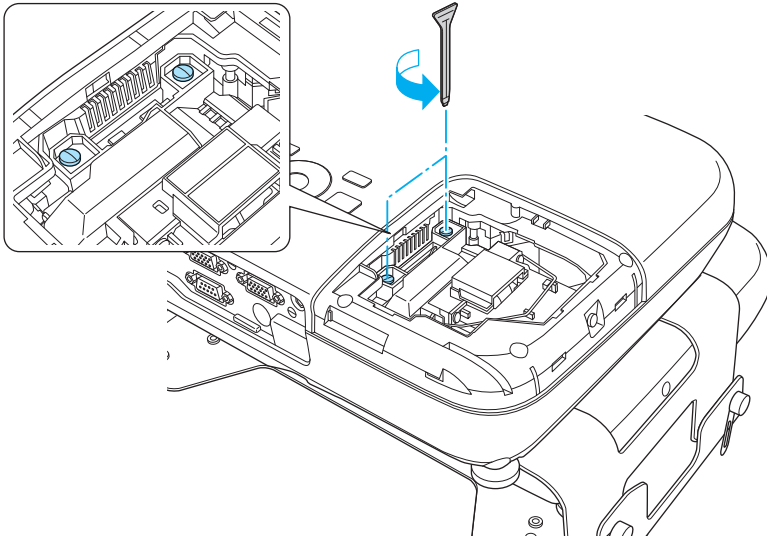

- 4** Take out the old Lamp by pulling the handle.  
If the Lamp is cracked, replace it with a new lamp, or contact your local dealer for further advice.

 [Epson Projector Contact List](#)

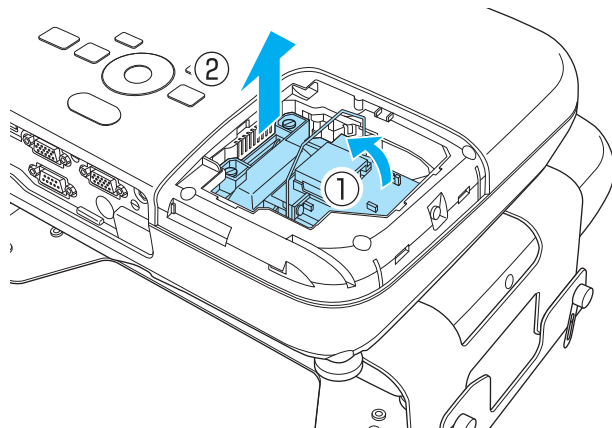

- 5** Install the new lamp.  
Insert the new Lamp along the guide rail in the correct direction so that it fits in place, push in firmly, and once it is fully inserted tighten the two screws.

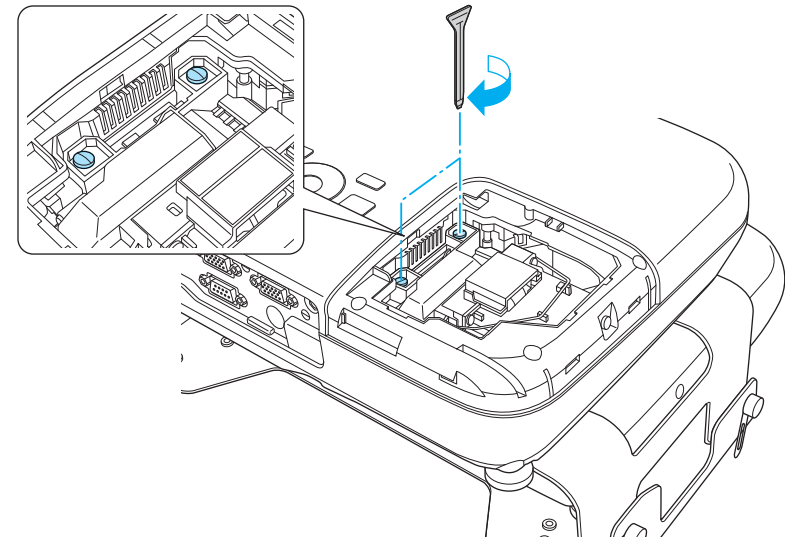
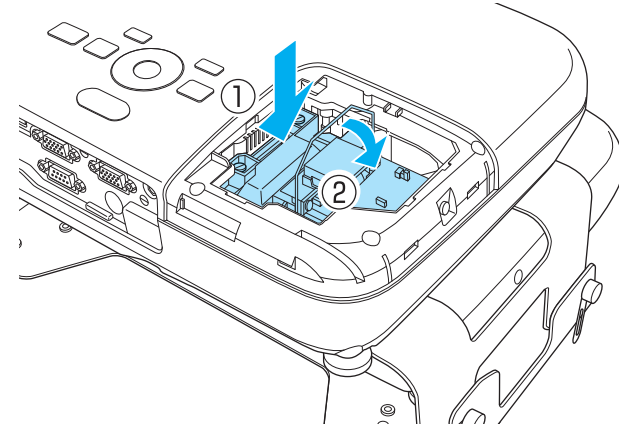

- 6** Replace the lamp cover.

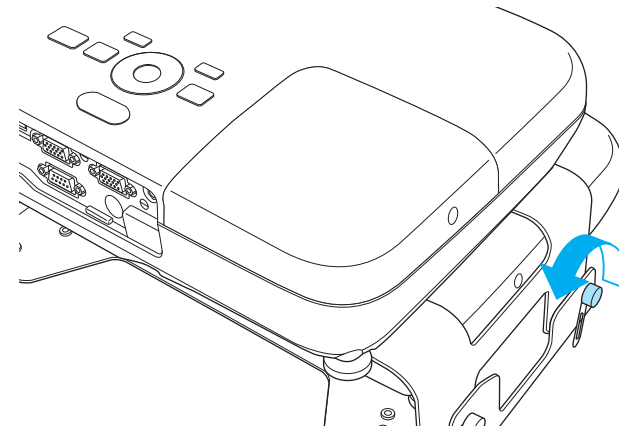
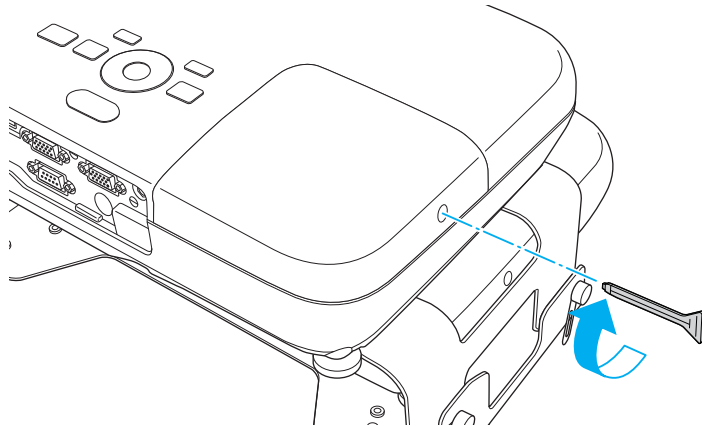

**3** Tilt back the commander section.

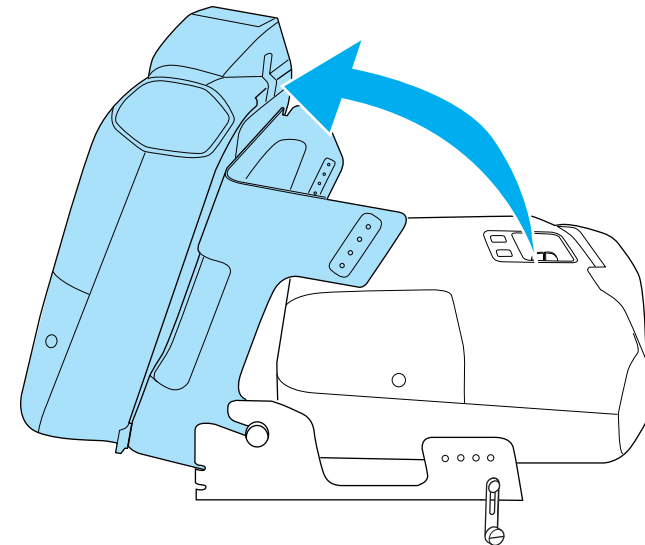

## Attention

- Make sure you install the lamp securely. If the lamp cover is removed, the power turns off automatically as a safety precaution. If the lamp or the lamp cover is not installed correctly, the power does not turn on.
- This product includes a lamp component that contains mercury (Hg). Please consult your local regulations regarding disposal or recycling. Do not dispose of it with normal waste.

Replacing the lamp for the receiver

- 1** After you turn off the projector's power and the confirmation buzzer beeps twice, disconnect the power cord.
- 2** Remove the stacker angle adjustment screws.

The steps from here on are the same as for replacing the commander's lamp.

☛ "Replacing the lamp for the commander" [p.85](#)

When you have finished replacing the lamp, return the commander section to its previous position, and then tighten the stacker angle adjustment screws.



## Caution

When returning the commander section, be careful not to trap your fingers in the moving mounting sections.

## Resetting the lamp hours

The projector records how long the lamp is turned on and a message and indicator notify you when it is time to replace the lamp. After replacing the lamp, make sure you reset the **Lamp Hours** from the Configuration menu.

☛ "Reset Menu" p.63



Only reset the **Lamp Hours** after the lamp has been replaced. Otherwise the lamp replacement period is not indicated correctly.

---

## Replacing the Air Filter

### Air filter replacement period

If the message is displayed frequently even though the air filter has been cleaned, replace the air filter.

### How to replace the air filter

The air filter can be replaced even when the projector is suspended from a ceiling.

This section explanation explains how to replace the commander's air filter. Replace the receiver's air filter in the same way.

- 1** After you turn off the projector's power and the confirmation buzzer beeps twice, disconnect the power cord.
- 2** Open the air filter cover.  
Place your finger into the groove at the top of the air filter, and pull it towards you.

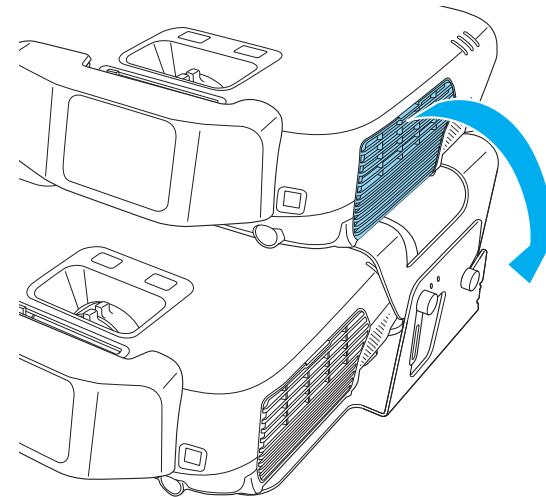

- 3** Remove the air filter.  
Grip the tab at the center of the air filter, and pull it towards you.



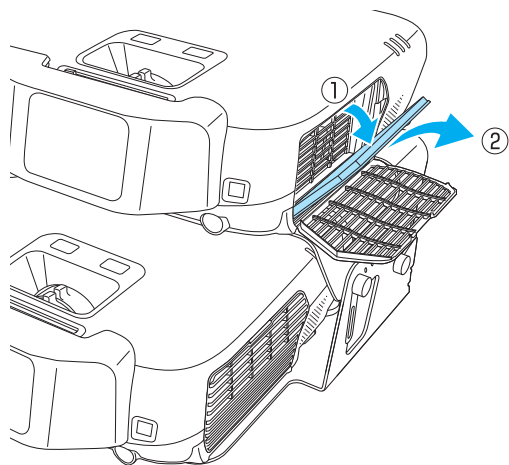

Dispose of used air filters properly in accordance with your local regulations.

Material of the frame part: ABS resin

Material of the filter part: Polyurethane foam

- 4** Install the new air filter.  
Press until it clicks into place.

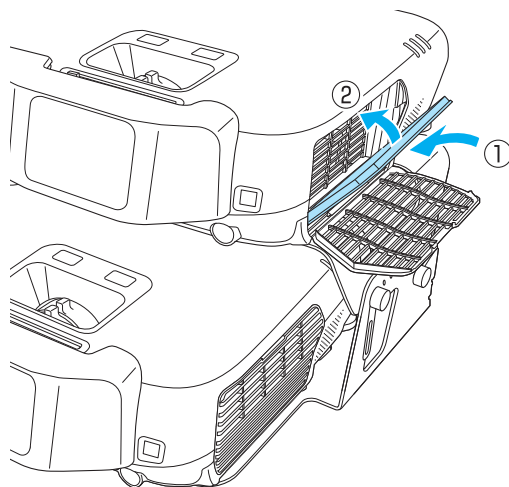

- 5** Close the air filter cover.



# Appendix

You can use only one of the projectors if one of them has malfunctioned or if you do not need to use two projectors.

## Turning On One Projector in a Stacked Configuration

### Turning on only the commander

While holding down the [1] button on the remote control, press the [⏻] button.

The commander turns on. The commander can now be used in the same way as shown in the following EB-W16 manual.

 [EB-W16/EH-TW550/EH-TW510 User's Guide](#)



The following functions are not supported.

- Viewing 3D images
- Projecting devices connected to the USB(TypeA) and USB(TypeB) ports
- Auto H/V-Keystone
- Focus help
- Screen Fit

### Turning on only the receiver

While holding down the [2] button on the remote control, press the [⏻] button. You can also press the [⏻] button on the receiver's control panel.

The receiver turns on. The receiver can now be used in the same way as shown in the following EB-W16 manual.

 [EB-W16/EH-TW550/EH-TW510 User's Guide](#)



The following functions are not supported.

- Viewing 3D images
- Projecting devices connected to the USB(TypeA) and USB(TypeB) ports
- Auto H/V-Keystone
- Focus help
- Screen Fit

## Clearing the Stacked Configuration and Using One Projector

**1** Turn on the projector (commander and receiver).



If the stacked configuration has already been cleared, the commander and receiver are not linked together and need to be turned on individually.

- Commander: While holding down the [1] button on the remote control, press the [⏻] button.
- Receiver: While holding down the [2] button on the remote control, press the [⏻] button. You can also press the [⏻] button on the receiver's control panel.

**2** Set **Stack Mode** to **Off** from the Configuration menu.

 [Extended - Operation - Stack Mode p.61](#)

**3** Press the [⏻] button on the commander and the receiver to turn them off.

**4** Disconnect the USB cable and the power cables from the commander or the receiver.

- 5** Loosen the screws for the stacker mount connector and the stacker angle adjustment section, and then remove the commander from the receiver.

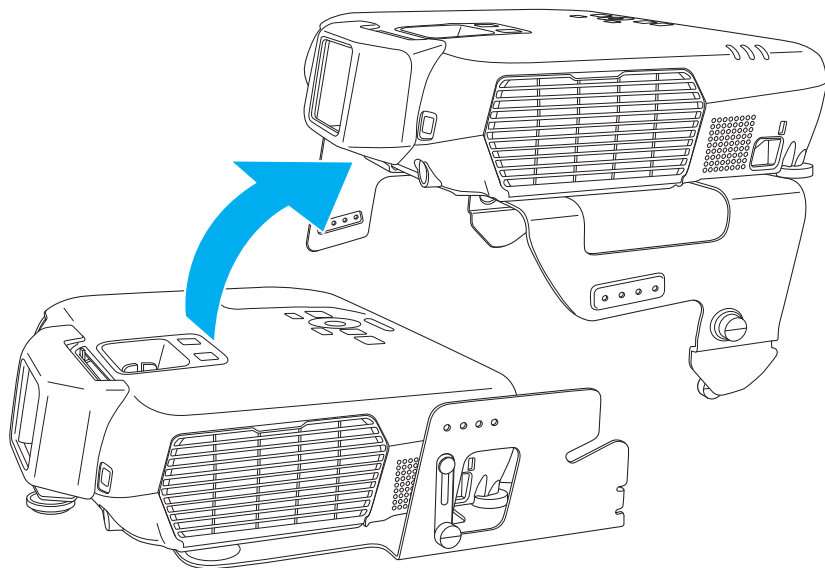

- 6** Remove the stacker mounts from the commander and the receiver.

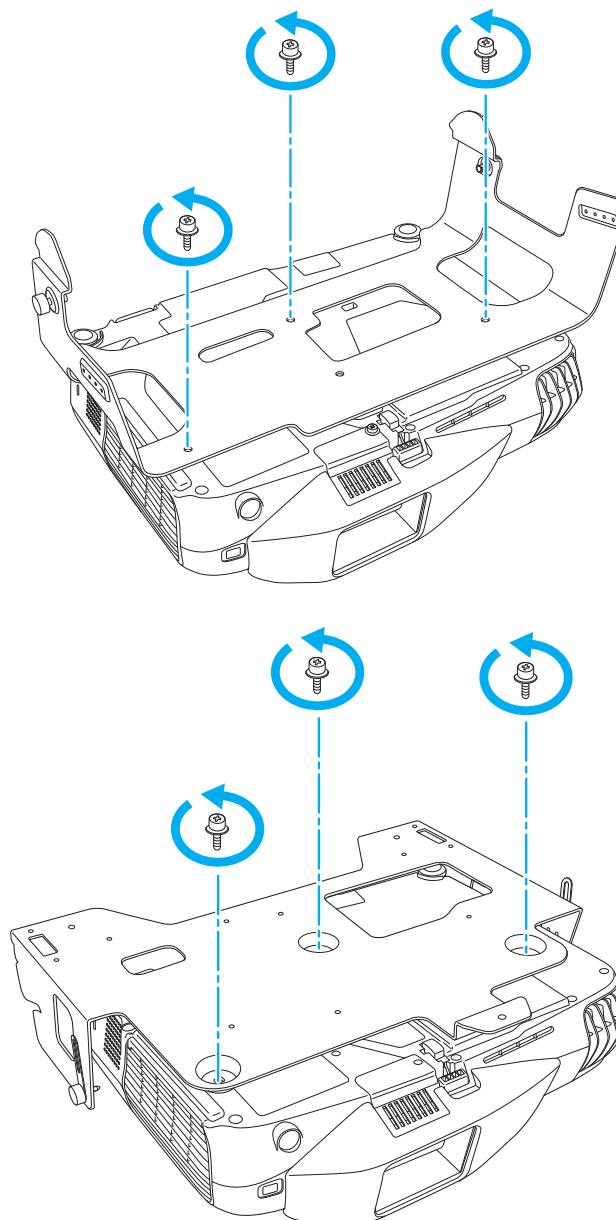

When the projector is turned on again, it can be used in the same way as shown in the following EB-W16 manual. (Except for viewing 3D images)

☞ [EB-W16/EH-TW550/EH-TW510 User's Guide](#)



When performing stack configuration again after, make the following settings for **Stack Mode**.

Commander: Set **Stack Mode** to **Commander**.

Receiver: Set **Stack Mode** to **Receiver**.

☞ **Extended - Operation - Stack Mode** [p.61](#)

The following optional accessories and consumables are available. Please purchase these products as and when needed. The following list of optional accessories and consumables is current as of: August 2012. Details of accessories are subject to change without notice and availability may vary depending on the country of purchase.



To view 3D images with the projectors, you need a silver screen designed for passive 3D images. Purchase a commercially available silver screen if necessary.

You cannot view 3D images on the optional screens.

## Optional Accessories

### Passive 3D Glasses (standard five piece set) ELPGS02A

### Passive 3D Glasses (five piece set for children) ELPGS02B

Passive polarized 3D glasses. Use these when viewing 3D images with the projectors.

### Interactive Unit ELPIU01

Use when operating the computer screen on the projection surface. The interactive unit cannot be used with a silver screen.

### 50" portable screen ELPSC32

A compact screen that can be carried easily. ([Aspect Ratio](#)▶▶ 4:3)

### 60" portable screen ELPSC27

### 80" portable screen ELPSC28

### 100" screen ELPSC29

Portable roll-type screens. (aspect ratio 4:3)

### 70" portable screen ELPSC23

### 80" portable screen ELPSC24

### 90" portable screen ELPSC25

Portable roll-type screens. (aspect ratio 16:10)

### 53" portable screen ELPSC30

### 64" portable screen ELPSC31

Portable magnetic screens. (aspect ratio 4:3)

### Multi-aspect screen ELPSC26

This is a portable multi-aspect screen.

### Computer cable ELPKC02

(1.8 m - for mini D-Sub15-pin/mini D-Sub 15pin)

This is the same as the computer cable supplied with the projector.

### Computer cable ELPKC09

(3 m - for mini D-Sub15-pin/mini D-Sub 15pin)

### Computer cable ELPKC10

(20 m - for mini D-Sub15-pin/mini D-Sub 15pin)

Use one of these longer cables if the computer cable supplied with the projector is too short.

### Component video cable ELPKC19

(3 m - for mini D-Sub 15-pin/RCA male×3)

Use to connect a [component video](#)▶▶ source.

### Ceiling pipe (450 mm)\* ELPFP13

### Ceiling pipe (700 mm)\* ELPFP14

Use when installing the projector on a high ceiling.

### Ceiling mount\* ELPMB23

Use when installing the projector on a ceiling.

\* Special expertise is required to suspend the projector from a ceiling. Contact your local dealer or the nearest address provided in the Epson Projector Contact List.

👉 [Epson Projector Contact List](#)



---

### Consumables

**Lamp unit ELPLP67**

Use as a replacement for used lamps.

**Air filter ELPAF42**

Use as a replacement for used air filters.

## Projection Distance

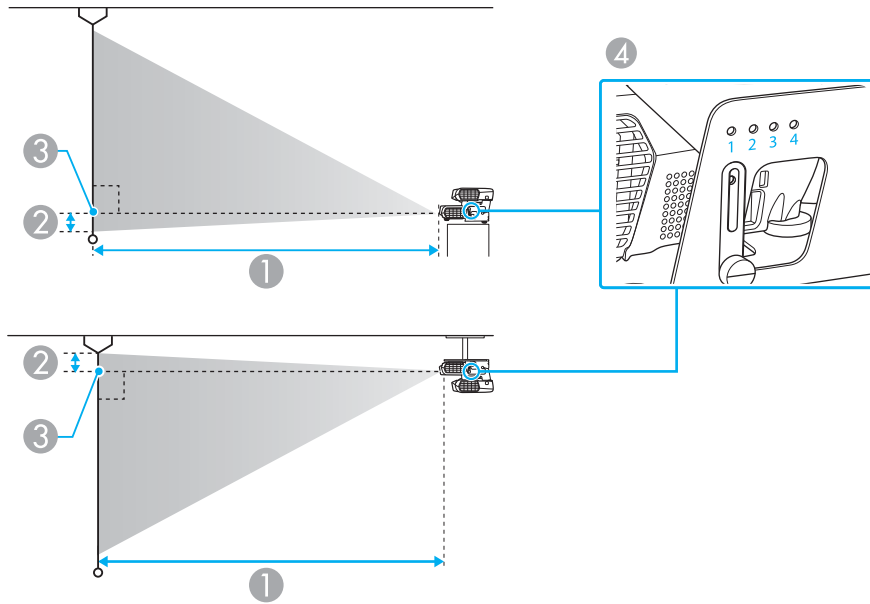

- ① Projection distance
- ② Distance from the center of the receiver's lens to the base of the screen (or to the top of the screen, if suspended from a ceiling)
- ③ Center of lens
- ④ Screw hole numbers (for angle adjustment)



When viewing 3D images, you can use screen sizes up to 120".

Unit: cm

4:3 Screen Size		①	②	④
		Minimum to Maximum		
80"	160x120	281 - 306	-11	No.4

4:3 Screen Size		①	②	④
		Minimum to Maximum		
90"	180x140	316 - 345	-12	No.3
100"	200x150	351 - 383	-14	
110"	220x170	387 - 422	-15	No.2
120"	240x180	422 - 461	-16	
130"	260x200	458 - 499	-18	No.1
140"	280x210	493 - 538	-19	
150"	300x230	529 - 577	-20	

Unit: cm

16:9 Screen Size		①	②	④
		Minimum to Maximum		
80"	180x100	255 - 278	-4	No.4
90"	200x110	287 - 313	-5	
100"	220x130	319 - 348	-5	No.3
110"	240x140	351 - 383	-6	
120"	270x150	383 - 418	-7	No.2
130"	290x160	415 - 453	-7	
140"	310x170	447 - 488	-8	No.1
150"	330x190	479 - 523	-8	

Unit: cm

16:10 Screen Size		①	②	④
		Minimum to Maximum		
80"	170x110	248 - 270	-10	No.4
90"	190x120	279 - 304	-11	
100"	220x130	310 - 338	-12	No.3



16:10 Screen Size		①	②	④
		Minimum to Maximum		
110"	240x150	341 - 372	-13	
120"	260x160	373 - 407	-14	No.2
130"	280x180	404 - 441	-16	
140"	300x190	435 - 475	-17	No.1
150"	320x200	467 - 509	-18	

## Supported Resolutions

### Computer signals (analog RGB)

Signal	Refresh Rate (Hz)	Resolution (dots)
VGA	60/72/75/85	640x480
SVGA	56/60/72/75/85	800x600
XGA	60/70/75/85	1024x768
WXGA	60	1280x768
	60	1366x768
	60/75/85	1280x800
WXGA+	60/75/85	1440x900
WXGA++	60	1600x900
SXGA	70/75/85	1152x864
	60/75/85	1280x1024
	60/75/85	1280x960
SXGA+	60/75	1400x1050
WSXGA+*1	60	1680x1050
UXGA	60	1600x1200
MAC13"	67	640x480
MAC16"	75	832x624
MAC19"	75	1024x768
	59	1024x768
MAC21"	75	1152x870

\*1 Only compatible when **Wide** is selected as the **Resolution** from the Configuration menu.

Even when signals other than those mentioned above are input, it is likely that the image can be projected. However, not all functions may be supported.

### Component Video

Signal	Refresh Rate (Hz)	Resolution (dots)
SDTV (480i)	60	720x480
SDTV (576i)	50	720x576
SDTV (480p)	60	720x480
SDTV (576p)	50	720x576
HDTV (720p)	50/60	1280x720
HDTV (1080i)	50/60	1920x1080

### Composite video

Signal	Refresh Rate (Hz)	Resolution (dots)
TV (NTSC)	60	720x480
TV (SECAM)	50	720x576
TV (PAL)	50/60	720x576

### Input signal from the HDMI port

Signal	Refresh Rate (Hz)	Resolution (dots)
VGA	60	640x480
SVGA	60	800x600
XGA	60	1024x768
WXGA	60	1280x800
	60	1366x768
WXGA+	60	1440x900
WXGA++	60	1600x900
WSXGA+	60	1680x1050

Signal	Refresh Rate (Hz)	Resolution (dots)
SXGA	60	1280x960
	60	1280x1024
SXGA+	60	1400x1050
UXGA	60	1600x1200
SDTV (480i/480p)	60	720x480
SDTV (576i/576p)	50	720x576
HDTV (720p)	50/60	1280x720
HDTV (1080i)	50/60	1920x1080
HDTV (1080p)	24/30/50/60	1920x1080

### 3D Input Signal

Signal	Refresh Rate (Hz)	Resolution (dots)	Frame Packing	Side by Side	Top and Bottom
HDTV750p (720p)	50/60	1280x720	✓	✓	✓
HDTV1125i (1080i)	50/60	1920x1080	-	✓	-
HDTV1125p (1080p)	50/60	1920x1080	-	✓	-
HDTV1125p (1080p)	24	1920x1080	✓	-	✓

## Projector General Specifications

Product name		EB-W16SK (Commander)	EB-W16SK (Receiver)
Dimensions		325 (W) x 79 (H) x 243 (D) mm	
Dimensions (in a stacked configuration)		372 (W) x 224 (H) x 350 (D) mm	
LCD panel size		0.59"	
Display method		Polysilicon TFT active matrix	
Resolution		1,024,000 pixels WXGA (1280 (W) x 800 (H) dots) x 3	
Focus adjustment		Manual	
Zoom adjustment		Manually (1-1.2)	
Lamp		UHE lamp, 200 W Model No.: ELPLP67	
Max. audio output		2 W	
Speaker		1	
Power supply		100-240V AC±10% 50/60Hz 2.9-1.3A	100-240V AC±10% 50/60Hz 2.9-1.3A
Power consumption	100 to 120 V area	Operating: 289 W Standby power consumption: 0.36 W	Operating: 289 W Standby power consumption: 0.36 W
	220 to 240 V area	Operating: 277 W Standby power consumption: 0.4 W	Operating: 277 W Standby power consumption: 0.4 W
Operating altitude		Altitude 0 to 2,286 m	
Operating temperature		5 to +35°C (No condensation)	
Storage temperature		-10 to +60°C (No condensation)	
Mass		Approx. 2.7 kg	
Mass (in a stacked configuration)		Approx. 7.9 kg	

Connectors	Computer1 port	1	Mini D-Sub15-pin (female)
------------	----------------	---	---------------------------



<b>Monitor Out/Computer2 port</b>	<b>1</b>	Mini D-Sub15-pin (female)
<b>Video port</b>	<b>1</b>	RCA pin jack
<b>S-Video port</b>	<b>1</b>	Mini DIN 4-pin
<b>Audio-L/R port</b>	<b>1</b>	RCA pin jack x 2 (L-R)
<b>Audio Out port</b>	<b>1</b>	Stereo mini jack (3.5Φ)
<b>HDMI port</b>	<b>1</b>	HDMI (Audio is only supported by PCM)
<b>USB(TypeA) port</b>	<b>1</b>	USB connector (Type A)
<b>USB(TypeB) port</b>	<b>1</b>	USB connector (Type B)
<b>RS-232C port</b>	<b>1</b>	Mini D-Sub 9-pin (male)

This product is also designed for IT power distribution system with phase-to-phase voltage 230V.

Angle of tilt

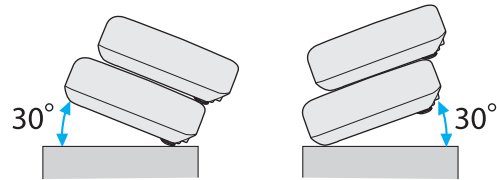

If you use the projector tilted at an angle of more than 30° it could be damaged and cause an accident.

**DECLARATION of CONFORMITY**

According to 47CFR, Part 2 and 15

Class B Personal Computers and Peripherals; and/or  
CPU Boards and Power Supplies used with Class B Personal Computers

We: Epson America, Inc.  
Located at: 3840 Kilroy Airport Way  
MS: 3-13  
Long Beach, CA 90806  
Tel: 562-981-3840

Declare under sole responsibility that the product identified herein, complies with 47CFR Part 2 and 15 of the FCC rules as a Class B digital device. Each product marketed, is identical to the representative unit tested and found to be compliant with the standards. Records maintained continue to reflect the equipment being produced can be expected to be within the variation accepted, due to quantity production and testing on a statistical basis as required by 47CFR 2.909. Operation is subject to the following two conditions : (1) this device may not cause harmful interference, and (2) this device must accept any interference received, including interference that may cause undesired operation.

Trade Name: EPSON  
Type of Product: LCD Projector  
Model: H493C/H494C/H499C

**FCC Compliance Statement  
For United States Users**

This equipment has been tested and found to comply with the limits for a Class B digital device, pursuant to Part 15 of the FCC Rules. These limits are designed to provide reasonable protection against harmful interference in a residential installation. This equipment generates, uses, and can radiate radio frequency energy and, if not installed and used in accordance with the instructions, may cause harmful interference to radio communications. However, there is no guarantee that interference will not occur in a particular installation. If this equipment does cause interference to radio and television reception, which can be determined by turning the equipment off and on, the user is encouraged to try to correct the interference by one or more of the following measures.

- Reorient or relocate the receiving antenna.
- Increase the separation between the equipment and receiver.
- Connect the equipment into an outlet on a circuit different from that to which the receiver is connected.
- Consult the dealer or an experienced radio/TV technician for help.

**WARNING**

The connection of a non-shielded equipment interface cable to this equipment will invalidate the FCC Certification or Declaration of this device and may cause interference levels which exceed the limits established by the FCC for this equipment. It is the responsibility of the user to obtain and use a shielded equipment interface cable with this device. If this equipment has more than one interface connector, do not leave cables connected to unused interfaces. Changes or modifications not expressly approved by the manufacturer could void the user's authority to operate the equipment.

EB-W16SK for stack configuration

**FCC Compliance Statement  
For United States Users**

This equipment has been tested and found to comply with the limits for a Class A digital device, pursuant to Part 15 of the FCC Rules. These limits are designed to provide reasonable protection against harmful interference when the equipment is operated in a commercial environment. This equipment generates, uses, and can radiate radio frequency energy and, if not installed and used in accordance with the instruction manual, may cause harmful interference to radio communications. Operation of this equipment in a residential area is likely to cause harmful interference in which case the user will be required to correct the interference at this own expense.



Units: mm

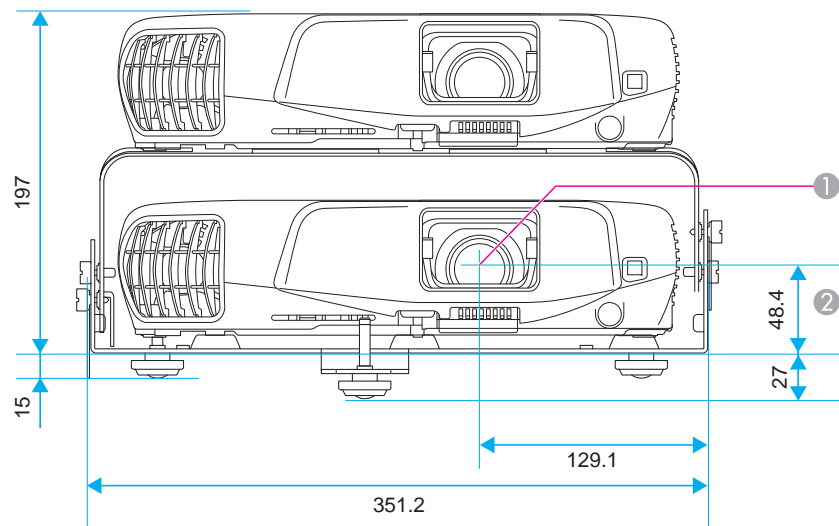

- ① Center of lens
- ② Distance from center of lens to suspension bracket fixing point

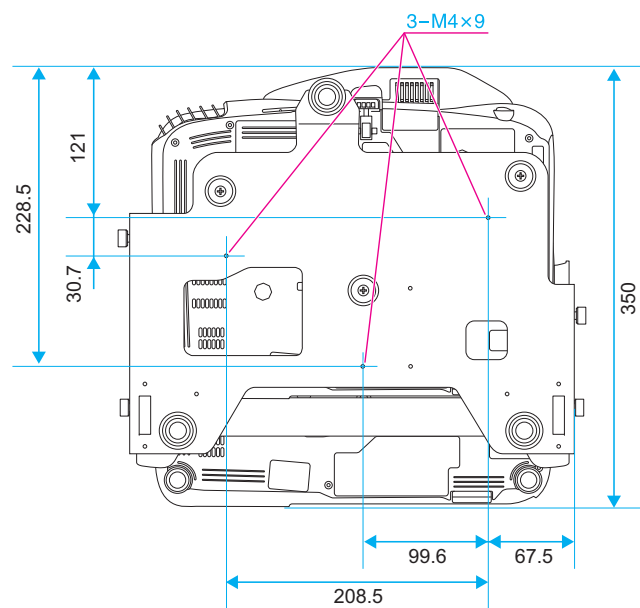

This section briefly explains the difficult terms that are not explained in the text of this guide. For details, refer to other commercially available publications.

<b>Aspect Ratio</b>	The ratio between an image's length and its height. Screens with a horizontal:vertical ratio of 16:9, such as HDTV screens, are known as wide screens. SDTV and general computer displays have an aspect ratio of 4:3.
<b>Component Video</b>	A method that separates the video signal into a luminance component (Y), and a blue minus luminance (Cb or Pb) and a red minus luminance (Cr or Pr).
<b>Composite video</b>	A method that combines the video signal into a luminance component and a color component for transmission down a single cable.
<b>Contrast</b>	The relative brightness of the light and dark areas of an image can be increased or decreased to make text and graphics stand out more clearly, or to make them appear softer. Adjusting this particular property of an image is called contrast adjustment.
<b>HDCP</b>	HDCP is an abbreviation for High-bandwidth Digital Content Protection. It is used to prevent illegal copying and protect copyrights by encrypting digital signals sent over DVI and HDMI ports. Because the HDMI port and DisplayPort on this projector supports HDCP, it can project digital images protected by HDCP technology. However, the projector may not be able to project images protected with updated or revised versions of HDCP encryption.
<b>HDTV</b>	An abbreviation for High-Definition Television that refers to high-definition systems which satisfy the following conditions. <ul style="list-style-type: none"> <li>• Vertical resolution of 720p or 1080i or greater (p = <a href="#">Progressive</a>, i = <a href="#">Interlace</a>)</li> <li>• Screen <a href="#">aspect ratio</a> of 16:9</li> </ul>
<b>Interlace</b>	Transmits information needed to create one screen by sending every other line, starting from the top of the image and working down to the bottom. Images are more likely to flicker because one frame is displayed every other line.
<b>Progressive</b>	Projects information to create one screen at a time, displaying the image for one frame. Even though the number of scan lines is the same, the amount of flicker in images decreases because the volume of information has doubled compared with an interlace system.
<b>Refresh Rate</b>	The light-emitting element of a display maintains the same luminosity and color for an extremely short time. Because of this, the image must be scanned many times per second to refresh the light-emitting element. The number of refresh operations per second is called the Refresh rate and is expressed in hertz (Hz).
<b>SDTV</b>	An abbreviation for Standard Definition Television that refers to standard television systems which do not satisfy the conditions for <a href="#">HDTV</a> High-Definition Television.
<b>sRGB</b>	An international standard for color intervals that was formulated so that colors that are reproduced by video equipment can be handled easily by computer operating systems (OS) and the Internet. If the connected source has an sRGB mode, set both the projector and the connected signal source to sRGB.
<b>SVGA</b>	A screen size standard with a resolution of 800 (horizontal) x 600 (vertical) dots.
<b>SXGA</b>	A screen size standard with a resolution of 1,280 (horizontal) x 1,024 (vertical) dots.
<b>Sync.</b>	The signals output from computers have a specific frequency. If the projector frequency does not match this frequency, the resulting images are not of a good quality. The process of matching the phases of these signals (the relative position of the crests and the troughs in the signal) is called Synchronization. If the signals are not synchronized, flickering, blurriness, and horizontal interference occur.



<b>Tracking</b>	The signals output from computers have a specific frequency. If the projector frequency does not match this frequency, the resulting images are not of a good quality. The process of matching the frequency of these signals (the number of crests in the signal) is called Tracking. If Tracking is not carried out correctly, wide vertical stripes appear in the signal.
<b>VGA</b>	A screen size standard with a resolution of 640 (horizontal) x 480 (vertical) dots.
<b>XGA</b>	A screen size standard with a resolution of 1,024 (horizontal) x 768 (vertical) dots.

All rights reserved. No part of this publication may be reproduced, stored in a retrieval system, or transmitted in any form or by any means, electronic, mechanical, photocopying, recording, or otherwise, without the prior written permission of Seiko Epson Corporation. No patent liability is assumed with respect to the use of the information contained herein. Neither is any liability assumed for damages resulting from the use of the information contained herein.

Neither Seiko Epson Corporation nor its affiliates shall be liable to the purchaser of this product or third parties for damages, losses, costs, or expenses incurred by the purchaser or third parties as a result of: accident, misuse, or abuse of this product or unauthorized modifications, repairs, or alterations to this product, or (excluding the U.S.) failure to strictly comply with Seiko Epson Corporation's operating and maintenance instructions.

Seiko Epson Corporation shall not be liable against any damages or problems arising from the use of any options or any consumable products other than those designated as Original Epson Products or Epson Approved Products by Seiko Epson Corporation.

The contents of this guide may be changed or updated without further notice.

Illustrations in this guide and the actual projector may differ.

## Restriction of Use

When this product is used for applications requiring high reliability/safety such as transportation devices related to aviation, rail, marine, automotive etc.; disaster prevention devices; various safety devices etc; or functional/precision devices etc, you should use this product only after giving consideration to including fail-safes and redundancies into your design to maintain safety and total system reliability. Because this product was not intended for use in applications requiring extremely high reliability/safety such as aerospace equipment, main communication equipment, nuclear power control equipment, or medical equipment related to direct medical care etc, please make your own judgment on this product's suitability after a full evaluation.

## Warning

This is class A product. In a domestic environment this product may cause radio interference in which case the user may be required to take adequate measures.

## About Notations

Microsoft® Windows® 2000 operating system  
Microsoft® Windows® XP operating system  
Microsoft® Windows Vista® operating system  
Microsoft® Windows® 7 operating system

In this guide, the operating systems above are referred to as "Windows 2000," "Windows XP," "Windows Vista," and "Windows 7". Furthermore, the collective term Windows may be used to refer to Windows 2000, Windows XP, Windows Vista, and Windows 7, and multiple versions of Windows may be referred to as, for example, Windows 2000/XP/Vista, with the Windows notation omitted.

Mac OS X 10.3.x  
Mac OS X 10.4.x  
Mac OS X 10.5.x  
Mac OS X 10.6.x  
Mac OS X 10.7.x

In this guide, the operating systems above are referred to as "Mac OS X 10.3.9," "Mac OS X 10.4.x," "Mac OS X 10.5.x," "Mac OS X 10.6.x" and "Mac OS X 10.7.x". Furthermore, the collective term "Mac OS X" is used to refer to them.

## Trademarks and Copyrights

IBM, DOS/V, and XGA are trademarks or registered trademarks of International Business Machines Corporation.

Mac and Mac OS are trademarks of Apple Inc.

Microsoft, Windows, Windows Vista, PowerPoint, and Windows logo are trademarks or registered trademarks of Microsoft Corporation in the United States and/or other countries.

HDMI and High-Definition Multimedia Interface are the trademarks or registered trademarks of HDMI Licensing LLC. 

Other product names used herein are also for identification purposes only and may be trademarks of their respective owners. Epson disclaims any and all rights in those marks.

©SEIKO EPSON CORPORATION 2012. All rights reserved.

**3**

- 3D Presentation ..... 38
- 3D Theatre ..... 38

**A**

- A/V Mute ..... 45
- Air exhaust vent ..... 9
- Air filter replacement period ..... 88
- Aspect ..... 39, 59
- Audio Input ..... 61
- Auto Iris ..... 38, 58
- Auto Setup ..... 58
- Auto setup ..... 59

**B**

- Blackboard ..... 38

**C**

- Ceiling ..... 20, 61
- Ceiling mount fixing points ..... 12
- Cleaning ..... 82
- Cleaning the air filter and air intake vent . 83
- Cleaning the Projector's Surface ..... 82
- Color Mode ..... 37, 58
- Computer Port ..... 11
- Configuration menu ..... 56
- Consumables ..... 95
- Control panel ..... 13
- Control Panel Lock ..... 50, 60
- Cross ..... 47

**D**

- Direct Power On ..... 61
- Display ..... 61
- Display Background ..... 61
- Distance ..... 96
- Dynamic ..... 38

**E**

- ESC/VP21 ..... 53
- Extended menu ..... 61
- E-Zoom ..... 47

**F**

- Focus ring ..... 10
- Freeze ..... 46
- Front ..... 20, 61
- Full Lock ..... 50

**H**

- HDMI port ..... 11
- HDMI Video Range ..... 59
- Help function ..... 65
- High Altitude Mode ..... 61
- How to replace the air filter ..... 88
- How to replace the lamp ..... 84

**I**

- Image menu ..... 58
- Indicators ..... 67, 68
- Info menu ..... 62
- Input Signal ..... 59
- Input signal ..... 62

**L**

- Lamp cover ..... 10
- Lamp hours ..... 62
- Lamp indicator ..... 67
- Lamp replacement period ..... 84
- Language ..... 62
- Lens Cover Timer ..... 61

**M**

- Messages ..... 61
- Monitor Displays ..... 98

**N**

- Noise Reduction ..... 59

**O**

- Operating temperature ..... 100
- Operation ..... 61
- Optional accessories ..... 94
- Overheating ..... 68

**P**

- Part Names and Functions ..... 9
- Password protect ..... 48
- Password protect sticker ..... 49
- Photo ..... 38
- Power Consumption ..... 60
- Power indicator ..... 67
- Power inlet ..... 11
- Power On Protect ..... 48
- Presentation ..... 38
- Problem Solving ..... 67

Progressive .....	59
Projection .....	61

**R**

Rear .....	20, 61
Rear feet .....	13
Rear screen .....	20
Refresh Rate .....	62
Remote control .....	15
Remote receiver .....	10
Replacing batteries .....	17
Reset menu .....	63
Resetting the lamp operating time .....	63, 88
Resolution .....	62
RS-232C port .....	11

**S**

Screen size .....	96
Sensor .....	10
Settings menu .....	60
Signal menu .....	58
Sleep Mode .....	61
Source .....	62
Source Search .....	13, 34
Specifications .....	100
Sports .....	38
sRGB .....	38
Startup Screen .....	61
Storage temperature .....	100
Supported Monitor Displays .....	98
Sync info .....	62

**T**

Temp indicator .....	67
Theatre .....	38

**U**

USB(TypeA) port .....	11, 12
USB(TypeB) port .....	11
User Button .....	60
User's Logo Protect .....	48

**V**

Video Port .....	11
Video signal .....	59, 62
Volume .....	60
Volume Button .....	14

**W**

Whiteboard .....	38
------------------	----

**Z**

Zoom ring .....	10
-----------------	----